



Vehicle Repair Tools



REAL TOOLS FOR REAL WORK.™

Contents

04 |



Cordless IQ^V™ Tools and Accessories

Impact Wrenches and Drivers
Ratchets
Drills & Screwdrivers
Other tools
Batteries and Chargers

14 |



Air Impact Wrenches

1/4" and 3/8"
1/2"
3/4"
1" (pistol and rear handle)
Accessories
Service Kits

34 |



Air Ratchets

1/2"
3/8"
1/4"

38 |



Air Grinders

Die Grinders
Wheel Grinders

44 |



Air Finishing Tools

Air Sanders and Polishers
Pads, Disks and Bonnets

50 |



Air Hammers and Accessories

Air Hammer
Needle Scaler
Accessoires

54 |



Air Drills, Screwdrivers and Specialty Tools

Drills
Screwdrivers
Specialty Air Tools

62 |



Accessories

Couplings & Nipples
Hoses
Lubricants



The new IQ^V series are power tools how you want them – As powerful as air tools, the convenience of cordless.

Cordless IQ^V™ Tools and Accessories

- 06 | Impact Wrenches and Drivers
- 09 | Ratchets
- 10 | Drills & Screwdrivers
- 11 | Other Tools
- 12 | Batteries and Chargers

IQ^V Series WARRANTY

IQ^V Series includes IQ^{V20} and IQ^{V12}

3 Year Limited Warranty on Tools and Chargers	2 Year High-Capacity Battery Replacement	1 Year Tool, Battery & Charger Replacement
--	--	---

See ingersollrandproducts.com/cordless for official Terms & Conditions. May vary by country.

*Peter Mayrhofer isn't one to compromise between comfort and performance. He wants it all in one compact tool. The new IQ^V™ line lets him have it his way: The cordless Impact Wrenches can remove even the toughest bolts. They deliver all the power he needs, with the handling and accessibility he expects. **Peter Mayrhofer, Inzell***

Cordless IQ^V™ Tools and Accessories



W7152 1/2" ■ Tool only - 20 V



- 1360 Nm of Maximum reverse torque and 2030 Nm of Nut Busting Torque
- IQV Power Control System with 4 modes Max Power, Mid Power, Wrench Tight and Hand Tight
- IQV Brushless motor Technology
- 360° Shadowless Tasklight

Also available
W7172
3/4" Tool only - 20V



1/2" Drive Impact Wrench, Charger 12/20V, 2 BL2022 (5.0 Ah) Li-Ion batteries & Bag

Available in kits
W7152-K22-EU 1/2" Kit 5.0Ah
CCN: 47633406001
W7252-K22-EU 1/2" Kit 5.0Ah
CCN: 47633408001

Protection Boot
W7152-BOOT
CCN: 47621732001

Ref.	CCN	Battery	V	in	Nm	rpm	bpm	kg	mm	dB(A)	m/s ² /K ⁽¹⁾
W7152	47633386001	BL2022	20	1/2" □	1360	0-1900	2450	3.4	207	95.0	17.0/3.7
W7252	47633389001	BL2022	20	1/2" □	1360	0-1900	2450	3.6	257	95.0	17.2/2.3
W7172	47663441001	BL2022	20	3/4" □	1360	0-1900	2450	3,5	215	95.0	17.0/3.7

⁽¹⁾ ISO60745 – 3-axis measurement: vibration level/measurement uncertainty.

Weight to include tool + battery weights

Cordless IQ^V™ Tools and Accessories | Impact Wrenches and Drivers

W7150EU 1/2" ■ Tool only - 20 V



- 1,057 Nm of maximum torque and 1,486 Nm of nut-busting torque, that's best-in-class performance
- Steel-reinforced housings add strength for unmatched drop resistance
- Variable speed switch with electronic brake provides maximum control of the tool

Protection Boot
W7150-BOOT
CCN: 48401855IRI

Available in kits
W7150EU-K22 1/2" Kit 5.0 Ah
CCN: 47524963001

W5153 1/2" ■ Tool only - 20 V



- 500 Nm of maximum reverse torque and 750 Nm of nut-busting torque
- IQV Power Control System with 4 modes Max Power, Mid Power, Wrench Tight, and Hand Tight
- IQV brushless motor technology
- Shadowless task light

Also available
W5133
3/8" Tool only - 20 V
Protection Boot
W5132-BOOT
CCN: 47555745001

Available in kits
W5153-K22-EU 1/2" Kit 2.5 & 5.0 Ah
CCN: 47637362001
W5133-K22-EU 3/8" Kit 2.5 & 5.0 Ah
CCN: 47637349001



1/2" Drive Impact Wrench, Charger 12/20V, 2 BL2022 (5.0 Ah) Li-Ion Batteries and Case



1/2" Drive Impact Wrench, Charger 12/20V, BL2012 (2.5 Ah), BL2022 (5.0 Ah) Li-Ion batteries & Bag

W5111 1/4" ⚙️ Tool only - 20 V



- 260 Nm of maximum torque in reverse
- Steel-reinforced housings add strength for unmatched drop resistance
- Variable speed switch with electronic brake provides maximum control of the tool

Protection Boot
W5111-BOOT
CCN: 47499747001

Available in kits
W5111-K22-EU 1/4" Hex Kit
CCN: 47530971001



1/4" Hex Impact Driver, Charger 12/20 V, 2 BL2012 (2.5 Ah) Li-Ion Batteries & Case

Ref.	CCN	Battery	V	in	Nm	rpm	bpm	kg	mm	dB(A)	m/s ² /K ⁽¹⁾
W7150EU	48391692	BL2022	20	1/2" □	1,057	1,900	2,300	3.10	238	89.0	12.2/1.8
W5133	47636405001	BL2022	20	3/8" □	500	2,100	3,300	2.40	179	90.0	12.6/1.7
		BL2012	20	3/8" □	400	2,100	3,100	2.10	179	90.0	16.1/2.6
W5153	47636406001	BL2022	20	1/2" □	500	2,100	3,300	2.40	183	90.0	12.6/1.7
		BL2012	20	1/2" □	400	2,100	3,100	2.10	183	90.0	16.1/2.6
W5111	48620793	BL2012	20	1/4" ⚙️	240	1,900	2,800	1.60	154	86.0	4.7/1.2

⁽¹⁾ ISO60745 – 3-axis measurement: vibration level/measurement uncertainty.

Weight to include tool + battery weights

Cordless IQ^{VTM} Tools and Accessories | Impact Wrenches and Drivers

W1110

1/4"  Tool only - 12 V



- 135 Nm of maximum torque
- Steel-reinforced housings add strength for unmatched drop resistance
- Variable speed switch with electronic brake provides maximum control of the tool

Available in kits

W1110EU-K2 1/4" Hex Kit
CCN: 47500087001



1/4" Hex Impact Driver, Charger,
2 BL1203 (2.0 Ah) Li-Ion Batteries

W1120

1/4"  Tool only - 12 V



- 135 Nm of maximum torque
- Steel-reinforced housings add strength for unmatched drop resistance
- Variable speed switch with electronic brake provides maximum control of the tool

Available in kits

W1120EU-K2 1/4" Kit
CCN: 47500088001



1/4" Drive Impact Wrench, Charger,
2 BL1203 (2.0 Ah) Li-Ion Batteries

W1130

3/8"  Tool only - 12 V





- 135 Nm of maximum torque
- Steel-reinforced housings add strength for unmatched drop resistance
- Variable speed switch with electronic brake provides maximum control of the tool

Available in kits

W1130EU-K2 3/8" Kit
CCN: 47500089001



3/8" Drive Impact Wrench, Charger,
2 BL1203 (2.0 Ah) Li-Ion Batteries

Ref.	CCN	Battery	V	in	Nm	rpm	bpm	kg	mm	dB(A)	m/s ² /K ⁽¹⁾
W1110	47500078001	BL1203	12	1/4" 	135	1,900	3,300	1.05	150	82.0	4.5/3.0
W1120	47500081001	BL1203	12	1/4" 	135	2,700	3,300	1.04	150	82.0	3.8/2.7
W1130	47500084001	BL1203	12	3/8" 	135	2,700	3,300	1.04	150	82.0	3.8/2.7

⁽¹⁾ ISO60745 – 3-axis measurement: vibration level/measurement uncertainty.

Weight to include tool + battery weights

Cordless IQ^{VTM} Tools and Accessories | Ratchets

W5350

1/2"  Tool only - 20 V



- 245 Nm of maximum torque
- Variable speed switch with electronic brake provides maximum control of the tool
- No torque reaction

Also available

W5330
3/8" Tool only - 20 V

Protection Boot

W5330-BOOT
CCN: 47517635001

Available in kits

W5350-K12-EU 1/2" Kit
CCN: 47530981001

W5330-K12-EU 3/8" Kit
CCN: 47530980001



1/2" Drive Impact Wrench, Charger 12/20 V,
1 BL2012 (2.5 Ah) Li-Ion Battery & Case

R3150

1/2"  Tool only - 20 V



- 73 Nm of maximum torque
- 0-225 rpm free speed
- Variable-speed trigger allows easy starts and precise speed control

Also available

R3130
3/8" Tool only - 20 V

Available in kits

R3150-K12-EU 1/2" Kit
CCN: 47530968001

R3130-K12-EU 3/8" Kit
CCN: 47530966001



1/2" Drive Ratchet, Charger 12/20 V,
1 BL2012 (2.5 Ah) Li-Ion Battery & Case

R1130

3/8"  Tool only - 12 V



- 40 Nm of maximum torque
- 0-260 rpm free speed
- Variable-speed trigger allows easy starts and precise speed control
- Bright white LED

Also available

R1120
1/4" Tool only - 12 V







Available in kits

R1130EU-K1 3/8" Kit
CCN: 47500065001

R1120EU-K1 1/4" Kit
CCN: 47500064001



3/8" Ratchet, Charger,
1 BL1203 (2.0 Ah) Li-Ion Battery

Ref.	CCN	Battery	V	in	Nm	rpm	bpm	kg	mm	dB(A)	m/s ² /K ⁽¹⁾
W5350	47514541001	BL2012	20	1/2" 	245	1,900	3,000	3.10	238	89.0	12.2/1.8
W5330	47514540001	BL2012	20	3/8" 	245	1,900	3,000	2.30	170	90.0	11.3/2.6
R3130	48621023	BL2012	20	3/8" 	73	225	-	2.00	408	86.0	2.8/0.7
R3150	48621056	BL2012	20	1/2" 	73	225	-	2.00	408	86.0	2.8/0.7
R1130	47500062001	BL1203	12	3/8" 	40	260	-	0.98	280	76.0	< 2.5
R1120	47500060001	BL1202	20	1/4" 	73	225	-	0.98	408	86.0	2.8/0.7

⁽¹⁾ ISO60745 – 3-axis measurement: vibration level/measurement uncertainty.

Weight to include tool + battery weights

Cordless IQ^V™ Tools and Accessories | Drills & Screwdrivers

D5140

Tool only - 20 V



- 80 Nm of maximum torque
- Keyless chuck
- Variable speed switch with electronic brake provides maximum control of the tool
- Steel-reinforced housings add strength for unmatched drop resistance

Available in kits

D5140-K22-EU Kit 5.0 Ah
CCN: 47530987001



1/2" (13mm) Drill/Driver, Charger 12/20 V,
2 BL2022 (5.0 Ah) Li-Ion Batteries & Case

D1130

Tool only - 12 V



- 23 Nm of maximum torque
- Steel-reinforced housings add strength for unmatched drop resistance
- Variable speed switch with electronic brake provides maximum control of the tool

Available in kits

D1130EU-K2 Kit
CCN: 47500116001



1/4" (6.5 mm) Drill/Driver, Charger,
2 BL1203 (2.0 Ah) Li-Ion Batteries

D1410

Tool only - 12 V



- 23 Nm of maximum torque
- Steel-reinforced housings add strength for unmatched drop resistance
- Variable speed switch with electronic brake provides maximum control of the tool

Available in kits

D1410EU-K2 Kit
CCN: 47500117001



1/4" Hex Screwdriver, Charger,
2 BL1203 (2.0 Ah) Li-Ion Batteries

Ref.	CCN	Battery	V	rpm	kg	mm	dB(A)	m/s ² /K ⁽¹⁾
D5140	48489546	BL2022, BL2010	20	1,900	2.45	245	75.0	< 2.5
D1130	47500112001	BL1203	12	1,600	1.10	190	64.0	< 2.5
D1410	47500114001	BL1203	12	1,600	0.95	130	64.0	< 2.5

⁽¹⁾ ISO60745 – 3-axis measurement: vibration level/measurement uncertainty.

Weight to include tool + battery weights

Cordless IQ^V™ Tools and Accessories | Other Tools

LUB5130

Tool only - 20 V



- Cordless Grease Gun
- Pressure 431 bar (6,250 psi)
- Flowrate 75 g/min
- Grease capacity 400 g
- 3 way loading: bulk, cartridge and manual
- Flexible hose 762 mm

Available in kits

LUB5130-K12-EU Kit
CCN: 47503151001



20 V Grease Gun, Charger 12/20 V,
1 BL2012 (2.5 Ah) Li-Ion Battery & Case

G1621

Tool only - 12 V



- Cordless Sander/Polisher
- 2" (50 mm) and 3" (75 mm) pads
- 2-speed gearbox, quick change spindle-lock and variable-speed for use on multiple surfaces
- Low noise level

Available in kits

G1621EU-K2 Kit
CCN: 47540140001



12V Sander/Polisher, Charger, 2 BL1203 (2.0 Ah)
Li-Ion Batteries and G1000-KIT-PAD

G1811

Tool only - 12 V



- Cordless Belt Sander
- 3/8" x 13" (10x330mm) Belt
- 8 positions arm
- Quick change lock

Available in kits

G1811EU-K2 Kit
CCN: 47559180001



12V Belt Sander, Charger, 2 BL1203 (2.0 Ah)
Li-Ion Batteries and Set of 6 belts

Ref.	CCN	Battery	V	rpm	HH:MM	Lumens	kg	mm	dB(A)	m/s ² /K ⁽¹⁾
LUB5130	47503006	BL2022, BL2012	20	–	–	–	3.70	490	66.0	2.5
G1621	47542795001	BL1203	12	2,200	0:20	–	1.30	144	67.0	3.0/0.8
G1811	47559185001	BL1203	12	7,000			1.00	212	67.0	3.0/0.8

⁽¹⁾ ISO60745 – 3-axis measurement: vibration level/measurement uncertainty.

Weight to include tool + battery weights

Cordless IQ^V™ Tools and Accessories | Other tools, Batteries and Chargers

C1101

Tool only - 20 V



- Cordless Recip Saw
- 3300 spm
- Adjustable guard
- Inline profile for easy access

Available in kits

C1101EU-K2 Kit
CCN: 47559320001



12V Recip Saw, Charger, 2 BL1203 (2.0 Ah) Li-Ion Batteries and 6 Blades P4EV-6

L5110

Tool only - 20 V



- Ultra-bright white LED casts 180 lumens
- Compatible with all IQV20 batteries
- Multi-position head, standing base and hang hook allow for lighting from above or below at any angle
- Run time:
12.5 hours (BL2012)/
15 hours (BL2010)/
22 hours (BL2022)

Also available

L1110

Tool only - 12 V

BL1203

12 V - 2.0 Ah Li-Ion



- Performance - Each battery provides r2.0 Ah of 12 V power, intelligently managed by the IQV12 Series system for maximum tool runtime
- Durability - Positive-lock system emits highly audible click when properly secured in tool, helping to eliminate drops and damage
- Ergonomics - Fuel gauge and patent-pending dual side button design for easier battery installation

Cordless IQ^V™ Tools and Accessories | Batteries and Chargers

BL2012

20 V - 2.5 Ah, Li-Ion



- Performance: The BL2012 x2.5 delivers 100% longer run time than its predecessor at the same size and weight.
- Ergonomic: patent-pending dual side button designed for easier battery installation.
- Durability: The intelligent Battery Management System (BMS) allows the battery to communicate with the tool and charger to offer triple battery protection, prevent over loading, over charging and over discharging for longer tool and battery life.

Protection Boot

BL2005-BOOT
CCN: 47510965001

BL2022

20 V - 5.0 Ah, Li-Ion



- Performance: The BL2022 x5.0 delivers 68% longer run time than its predecessor at the same size and weight.
- Ergonomic: patent-pending dual side button designed for easier battery installation.
- Durability: The intelligent Battery Management System (BMS) allows the battery to communicate with the tool and charger to offer triple battery protection, prevent over loading, over charging and over discharging for longer tool and battery life.

Protection Boot

BL2010-BOOT
CCN: 47510964001

BC1110-EU

Charger 12 V batteries



- Performance: Brings fully depleted battery to 100% charge in about an hour
- Durability: Engineered composite housing withstands wear, abrasions, drops, and can be securely screw mounted to a wall or toolbox

BC1121-EU

Charger 12/20 V batteries



- Versatility: One charger for all your Ingersoll Rand batteries, fully compatible with all existing 20 V and 12 V batteries and that can charge USB mobile devices
- Durability: Engineered composite housing withstands wear, abrasions, drops, and can be securely screw mounted to a wall or toolbox

Ref.	CCN	Battery	V	Strokes per Minute	Strokes Length mm	HH:MM	Lumens	kg	mm	dB(A)	m/s ² /K ⁽¹⁾
C1101	47559324001	BL1203	12	3,300	14	-	-	0.97	298	77.0	17.9/7.8
L5110	48489561	BL2012	20	-	-	12:50	180	0.86	236	-	-
L1110	47500109001	BL1203	12	-	-	6:50	180	0.58	217	-	-

⁽¹⁾ ISO60745 - 3-axis measurement: vibration level/measurement uncertainty.

Weight to include tool + battery weights

Ref.	CCN	V	g
BL1203	24206179	12	0.25
BL2012	47515903001	20	0.41
BL2022	47515902001	20	0.72
BC1110-EU	47499973001	12	-
BC1121-EU	47507874001	12/20	-

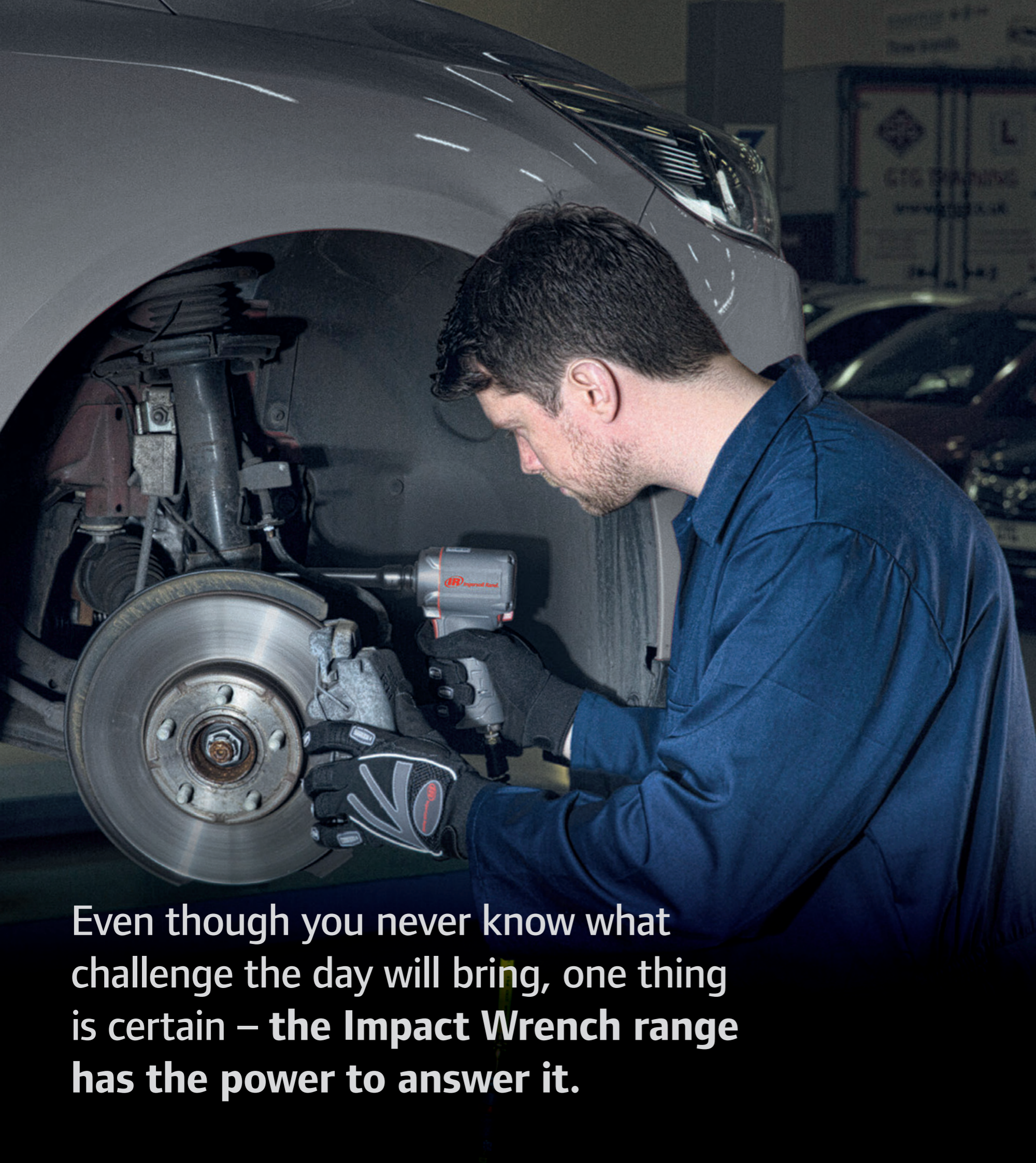

Even though you never know what challenge the day will bring, one thing is certain – the **Impact Wrench** range has the power to answer it.

Air Impact Wrenches

- 16 | 1/4" and 3/8"
- 20 | 1/2"
- 24 | 3/4"
- 26 | 1" (pistol and rear handle)
- 30 | Accessories
- 33 | Service Kits

Torque is key to Jose dos Santos. With Ingersoll Rands industry-leading range of Air Impact Wrenches he has all the power he needs at his fingertips. After having tested them, the tools have proven to deliver more performance than he was expecting. And the wide range of sizes offers him the perfect match for his workplace.

Jose dos Santos, Bilbao

Air Impact Wrenches



2101XPA 1/4" ■ Ring type



- Powerful impact mechanism delivers 75 Nm of max torque
- Hard-hitting five-vane motor for smooth and robust performance
- Easily accessible forward/reverse switch for one-handed operation
- Ideal for those hard-to-reach places where conventional tools can't go

Also available
2102XPA
 3/8" Ring type
2101XPA-QC
 1/4" Hex Quick change

Available in kits

2101KA
 CCN: 47520766001



Includes 1/4" impact and 10 sockets set

Air Impact Wrenches | 1/4" and 3/8"

2115QTiMAX 3/8" ■ Ring type



- 407 Nm of maximum torque in reverse
- Only 1.13 kg and 151 mm
- Twin-hammer impact mechanism
- Titanium hammer case and composite housing
- 4-position power regulator
- 1-hand forward and reverse switch
- Two-year warranty

Protection Boot
2115M-BOOT
 CCN: 45602174

15QMAX 3/8" ■ Ring type



- Delivering 520 Nm of maximum reverse torque at only 1.09 kg
- Push buttons for one-hand forward/reverse
- 3-mode selection power regulator
- 117 mm length
- Quiet Tool
- Two-year warranty

Protection Boot
35-BOOT
 CCN: 47555720001

2015MAX 3/8" ■ Ring type



- 244 Nm of maximum torque in reverse
- Only 1.54 kg
- Jumbo-hammer impact mechanism
- Composite housing
- 2-position power regulator

Protection Boot
2015-BOOT
 CCN: 47109715IRI

Ref.	CCN	in	Nm	Nm	rpm	bpm	kg	mm	in	mm	l/s	l/s	dB(A)	m/s ² /K ⁽¹⁾
2101XPA	47520745001	1/4" □	75	75	14,500	3,650	0.70	175	1/4 NPT	10	4.7	-	84.8	3.0/1.0
2102XPA	47520747001	3/8" □	75	75	14,500	3,650	0.70	175	1/4 NPT	10	4.7	-	84.8	3.0/1.0
2101XPA-QC	47520746001	1/4" □	75	75	14,500	3,650	0.70	183	1/4 NPT	10	4.7	-	84.8	3.0/1.0

⁽¹⁾ ISO28927 – 3-axis measurement: vibration level/measurement uncertainty.
 Performance at 6.2 bar (90 psi)

Ref.	CCN	in	Nm	Nm	rpm	bpm	kg	mm	in	mm	l/s	l/s	dB(A)	m/s ² /K ⁽¹⁾
2115QTiMAX	45587326	3/8" □	407	312	1,500	1,500	1.13	151	1/4 NPT	10	1.9	8.00	93.2	7.5/1.8
15QMAX	47544405001	3/8" □	520	420	6,000	1,350	1.09	117	1/4 NPT	10	1.9	8.02	89.7	5.5/0.9
2015MAX	45533775	3/8" □	244	190	7,100	2,100	1.54	332	1/4 NPT	10	1.6	9.00	96.6	17.4/3.0

⁽¹⁾ ISO28927 – 3-axis measurement: vibration level/measurement uncertainty.
 Performance at 6.2 bar (90 psi)

Air Impact Wrenches | 1/4" and 3/8"

2115QXPA 3/8" ■ Ring type



- 407Nm of Max reverse torque
- Only 1.1 kg and 155 mm
- Twin-hammer impact mechanism
- 4 position power regulation
- 1-hand forward and reverse switch
- Quiet Tool

Protection Boot
2115M-BOOT
CCN: 45602174

212 3/8" ■ Ring type



- 244 Nm of maximum torque in reverse
- Pressure-feed lubrication system automatically greases the impact mechanism for increased durability and reliability
- Wide range of power regulator settings helps adjusting the power to the application

LA158 3/8" ■ Ring type



- 136 Nm of maximum torque in reverse
- Small size to allow greater access to tight spaces
- Easy glide forward/reverse switch
- Wide range of power regulator settings helps adjusting the power to the application

Air Impact Wrenches | 1/4" and 3/8"

211 3/8" ■ Ring type

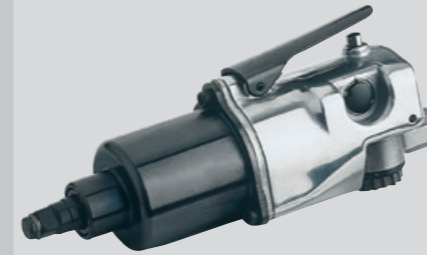

- 204 Nm of maximum torque in reverse
- Only 1.09 kg
- Jumbo-hammer impact mechanism
- 5-position power regulator

216B 3/8" ■ Ring type



- 271 Nm of maximum torque in reverse
- Only 1.27 kg
- Ball & cam impact mechanism
- Power regulator

Ref.	CCN	in	Nm	Nm	rpm	bpm	kg	mm	in	mm	l/s	l/s	dB(A)	m/s ² /K ⁽¹⁾
2115QXPA	2115QXPA	3/8" □	407	312	15,000	1,500	1.10	155	1/4 NPT	10	1.9	8.00	93,2	7,5/1,8
211	01197060	3/8" □	204	170	1,000	1,500	1.09	168	1/4 NPT	10	1.2	5.20	104.0	5.9/1.6
LA158	49825870	3/8" □	136	100	1,000	1,400	1.25	137	1/4 NPT	10	1.9	7.50	88.4	3.3/1.1

⁽¹⁾ ISO28927 – 3-axis measurement: vibration level/measurement uncertainty.
Performance at 6.2 bar (90 psi)

Ref.	CCN	in	Nm	Nm	rpm	bpm	kg	mm	in	mm	l/s	l/s	dB(A)	m/s ² /K ⁽¹⁾
212	01197003	3/8" □	244	170	1,000	1,500	1.31	152	1/4 NPT	10	1.2	5.20	97.5	6.5/1.0
216B	46806600	3/8" □	271	217	8,500	1,600	1.27	196	1/4 NPT	10	1.4	9.00	90.0	5.2/1.0

⁽¹⁾ ISO28927 – 3-axis measurement: vibration level/measurement uncertainty.
Performance at 6.2 bar (90 psi)

Air Impact Wrenches



36QMAX 1/2" ■ Ring type



- Delivering 640 Nm of maximum reverse torque and 815 Nm of nut busting torque at only 1.09 kg
- Push for one-hand forward / reverse
- 117 mm length
- Twin-Hammer mechanism for low vibrations
- Quiet Tool

Protection Boot
35-BOOT
CCN: 47555720001

Ref.	CCN	in	Nm	Nm	rpm	bpm	kg	mm	in	mm	l/s	l/s	dB(A)	m/s ² /K ⁽¹⁾
36QMAX	36QMAX	1/2" □	640	520	8,000	1,300	1.09	117	1/4 NPT	10	1.9	8.20	91.3	8.1 / 1.2

⁽¹⁾ ISO28927 – 3-axis measurement: vibration level/measurement uncertainty.

Performance at 6.2 bar (90 psi)

Air Impact Wrenches | 1/2"

2235QTiMAX 1/2" ■ Ring type



- MAX POWER with 1,220 Nm of maximum torque in reverse and 1,760 Nm of nut busting torque
- MAX DURABILITY with the titanium hammercase, the steel-wear plate and composite housing
- MAX RELIABILITY backed by a two-year warranty

Also available
2235QTiMAX-2

Protection Boot
2235M-BOOT
CCN: 47520153001

Available in kits
2235QTiMAX-10SK 10 sockets kit
CCN: 47521865001
2235QTiMAX-3SK 3 long sockets kit
CCN: 47521867001



2235QTiMAX + Impact Sockets 1/2"
(10, 11, 12, 13, 14, 17, 19, 21, 22, and 24 mm)

2125QTiMAX 1/2" ■ Ring type



- 450 Nm of maximum torque in reverse
- Only 1.14 kg and 155 mm
- Twin-hammer impact mechanism
- Titanium hammer case and composite housing
- 1-hand forward and reverse switch
- Two-year warranty

Protection Boot
2115M-BOOT
CCN: 45602174

2025MAX 1/2" ■ Ring type



- 244 Nm of maximum torque in reverse
- Only 1.54 kg
- Jumbo-hammer impact mechanism
- Composite housing
- 2-position power regulator

Protection Boot
2015-BOOT
CCN: 47109715IRI

Ref.	CCN	in	Nm	Nm	rpm	bpm	kg	mm	in	mm	l/s	l/s	dB(A)	m/s ² /K ⁽¹⁾
2235QTiMAX	47517574001	1/2" □	1,220	-	8,500	1,220	2.10	193	1/4 NPT	10	-	11.30	91.9	9.0/2.8
2235QTiMAX-2	47517884001	1/2" □	1,220	-	8,500	1,220	2.20	244	1/4 NPT	10	-	11.00	91.9	7.7/2.7
2125QTiMAX	45587524	1/2" □	450	340	1,500	1,500	1.14	155	1/4 NPT	10	1.9	8.00	93.2	7.5/1.8
2025MAX	47099247	1/2" □	244	190	7,100	1,500	1.54	332	1/4 NPT	10	1.7	9.00	96.6	17.4/3.0

⁽¹⁾ ISO28927 – 3-axis measurement: vibration level/measurement uncertainty.

Performance at 6.2 bar (90 psi)

Air Impact Wrenches | 1/2"

2235QXPA

1/2" ■ Ring type



- 1,220 Nm of maximum torque in reverse and 1,760 Nm of nut-busting torque
- Quiet technology
- Only 2,1 kg

Protection Boot

2235M-BOOT

CCN: 47520153001

2135QXPA

1/2" ■ Ring type



- 1,057 Nm of maximum torque in reverse and 1,490 Nm of nut busting torque
- Quiet technology
- Only 1.80 kg
- 4-position power regulator and 1-hand forward and reverse switch

Also available

2135QXPA-2

Ring type, long anvil 50 mm

2135QTL-2

1/2" Extended / Torque limited 75-100 Nm

Protection Boot

2135M-BOOT

CCN: 45545977

Available in kits

2135QXPA-10SK 10 sockets kit

CCN: 47521891001

2135QXPA-3SK 3 long sockets kit

CCN: 47521896001



2135QXPA + Impact Sockets 1/2" (10, 11, 12, 13, 14, 17, 19, 21, 22, and 24 mm)

2130XP

1/2" ■ Ring type



- 816 Nm maximum torque in reverse
- Ergonomic composite housing is light-weight, protects from cold air, and offers great operator comfort
- Full-stroke tease throttle
- Multi-position power management and easy glide forward/reverse switch

Protection Boot

2130-BOOT

CCN: 45505369

Available in kits

2130XP+SK4M3L 3 long sockets kit

CCN: 17021346

2130XP-K 10 sockets kit

CCN: 16985301



2130XP + Long Impact Sockets, insulated, thin-wall 1/2" (17, 19, and 21 mm)

Air Impact Wrenches | 1/2"

231GXP

1/2" ■ Ring type



- 610 Nm
- Twin-hammer impact mechanism
- Steel hammer case
- 5-position power regulator

Protection Boot

231-BOOT

CCN: 45505427

Available in kits

231GXP-K 10 sockets kit

CCN: 17000639



231GXP + Impact Sockets 1/2" (10, 11, 12, 13, 14, 17, 19, 21, 22, and 24 mm)

236

1/2" ■ Ring type



- 610 Nm of maximum torque in reverse
- Pressure-fed lubrication
- Feather-touch trigger allows precise delivery of power and speed

Protection Boot

236-BOOT

CCN: 45528148

Available in kits

236-SK 10 sockets kit

CCN: 17020843



236 + Impact Sockets 1/2" (10, 11, 12, 13, 14, 17, 19, 21, 22, and 24 mm)

Ref.	CCN	in	Nm	Nm	rpm	bpm	kg	mm	in	mm	l/s	l/s	dB(A)	m/s ² /K ⁽¹⁾
2235QXPA	47532836001	1/2" □	1,220	-	8,500	1,220	2.10	193	1/4 NPT	10	0.0	11.30	91.9	9.0/2.8
2135QXPA	47517913001	1/2" □	1,057	746	9,800	1,250	1.80	187	1/4 NPT	10	0.0	10.80	90.7	13.3/4.6
2135QXPA-2	47517914001	1/2" □	1,057	746	9,800	1,250	1.90	241	1/4 NPT	10	0.0	10.80	90.7	9.7/1.8
2135QTL-2	2135QTL-2	1/2" □	1,057	75-100	11,000	1,250	2.00	242	1/4 NPT	10	2.3	11.30	95.4	13.8 / 4,8
2130XP	80136112	1/2" □	816	474	9,500	1,200	1.90	187	1/4 NPT	10	2.1	10.40	94.3	8.9/2.0

⁽¹⁾ ISO28927 – 3-axis measurement: vibration level/measurement uncertainty. Performance at 6.2 bar (90 psi)

Ref.	CCN	in	Nm	Nm	rpm	bpm	kg	mm	in	mm	l/s	l/s	dB(A)	m/s ² /K ⁽¹⁾
231GXP	10566255	1/2" □	610	407	8,000	1,200	2.63	185	1/4 NPT	10	2.0	10.30	91.5	6.3/2.1
236	80171879	1/2" □	610	271	7,400	1,200	2.40	180	1/4 NPT	10	2.0	11.30	90.3	12.0/1.0

⁽¹⁾ ISO28927 – 3-axis measurement: vibration level/measurement uncertainty. Performance at 6.2 bar (90 psi)

Air Impact Wrenches



2145QiMAX 3/4" ■ Short anvil



- 1,830 Nm of maximum torque in reverse
- Ergonomic composite housing is lightweight, protects from cold air and offers great operator comfort
- The low weight of this tool will reduce operator fatigue
- 360° swivel inlet helps eliminate twisted hoses
- Two-year warranty

Protection Boot
2145M-BOOT
CCN: 48385033

Also available
2145QiMAX-3
Long anvil 75 mm
2145QiMAX-6
Long anvil 150 mm

Ref.	CCN	in	Nm	Nm	rpm	bpm	kg	mm	in	mm	l/s	l/s	dB(A)	m/s ² /K ⁽¹⁾
2145QiMAX	45624327	3/4" □	1,830	1,220	6,300	1,150	3.35	217	3/8 NPT	13	4.0	15.10	96.3	8.7/2.7
2145QiMAX-3	47119524	3/4" □	1,830	1,220	6,300	1,150	3.79	293	3/8 NPT	13	4.0	15.10	96.3	8.1/1.2
2145QiMAX-6	47121454	3/4" □	1,830	1,220	6,300	1,150	4.23	369	3/8 NPT	13	4.0	15.10	96.3	8.1/1.2

⁽¹⁾ ISO28927 – 3-axis measurement: vibration level/measurement uncertainty. Performance at 6.2 bar (90 psi)

Air Impact Wrenches | 3/4"

2161XP 3/4" ■ Short anvil



- 1,695 Nm
- Only 5.4 kg (2161XP)
- Twin-hammer impact mechanism
- Steel hammer case
- 3-position power regulator

Also available
2161XP-6
Long anvil 150 mm

Protection Boot
2161-BOOT
CCN: 45505401

261 3/4" ■ Short anvil



- 1,491 Nm
- Jumbo-hammer impact mechanism
- Steel hammer case
- 5-position power regulator

Also available
261-3
Long anvil 75 mm
261-6
Long anvil 150 mm

Protection Boot
261-BOOT
CCN: 45505468

259 3/4" ■ Short anvil



- 1,424 Nm
- Only 4.0 kg and 218 mm
- Swinging-hammer impact mechanism
- 2-position power regulator

Protection Boot
259-BOOT
CCN: 45661899

Ref.	CCN	in	Nm	Nm	rpm	bpm	kg	mm	in	mm	l/s	l/s	dB(A)	m/s ² /K ⁽¹⁾
2161XP	01372085	3/4" □	1,695	1,356	6,000	1,025	5.35	216	3/8 NPT	13	4.7	21.50	94.7	9.8/1.8
2161XP-6	01372093	3/4" □	1,695	1,356	6,000	1,025	5.94	370	3/8 NPT	13	4.7	21.50	94.7	9.8/1.8
261	01209758	3/4" □	1,491	813	5,500	1,000	5.62	224	3/8 NPT	13	4.5	17.90	98.1	10.4/1.3
261-3	01211101	3/4" □	1,491	813	5,500	1,000	5.90	300	3/8 NPT	13	4.5	17.90	98.1	10.4/1.3
261-6	01217199	3/4" □	1,491	813	5,500	1,000	6.21	376	3/8 NPT	13	4.5	17.90	98.1	10.4/1.3
259	45631918	3/4" □	1,424	1,085	6,500	1,000	4.00	218	3/8 NPT	10	3.8	14.20	91.6	6.4/0.8

⁽¹⁾ ISO28927 – 3-axis measurement: vibration level/measurement uncertainty. Performance at 6.2 bar (90 psi)

Air Impact Wrenches



2850MAX-6 1" ■ Long anvil 150 mm



- 2850 Nm of Max Reverse Torque
- Twin Hammer mechanism
- Built in auto lubrication system
- Light weight
- 2-Years Warranty

Also available
2850MAX
1" Short anvil

Ref.	CCN	in	Nm	Nm	rpm	bpm	kg	mm	in	mm	l/s	l/s	dB(A)	m/s ² /K ⁽¹⁾
2850MAX	2850MAX	1" □	2,850	2,280	5,500	770	8.8	334	1/2 NPT	19 mm	6.6	26.4	96.7	12.6 / 3.6
2850MAX-6	2850MAX-6	1" □	2,850	2,280	5,500	770	9.8	486	1/2 NPT	19 mm	6.6	26.4	96.7	10.3 / 1.9

⁽¹⁾ ISO28927 – 3-axis measurement: vibration level/measurement uncertainty.
Performance at 6.2 bar (90 psi)

Air Impact Wrenches | 1" (pistol and rear angle)

631L 1" ■ Long anvil 200 mm

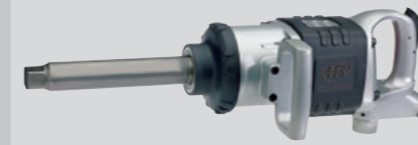

- 4,300 Nm of maximum torque
- Ergonomic auxiliary handle provides excellent manoeuvrability
- 4-position power regulator and forward/reverse control

285B-6 1" ■ Long anvil 150 mm

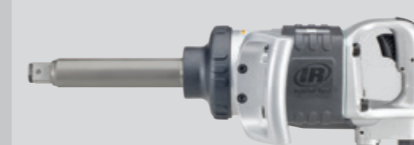

- Designed for operation at 8.3 bar dynamic (120 psi)
- 2,400 Nm
- Swinging-hammer impact mechanism
- 3-position power regulator

Also available
285B
1" Short anvil

280-6-EU 1" ■ Long anvil 150 mm



- 2,169 Nm
- Jumbo-hammer impact mechanism

Also available
280-EU
1" Short anvil

Ref.	CCN	in	Nm	Nm	rpm	bpm	kg	mm	in	mm	l/s	l/s	dB(A)	m/s ² /K ⁽¹⁾
631L	80183171	1" □	4,300	3,390	3,500	700	16.60	624	1/2 NPT	13	7.1	26.40	108.4	12.7/2.5
280-6-EU	01343144	1" □	2,169	1,356	6,000	750	10.80	470	1/2 NPT	13	4.7	26.00	109.1	21.8/3.8
280-EU	01343193	1" □	2,169	1,356	6,000	750	9.98	330	1/2 NPT	13	4.7	26.00	109.1	24.1/3.4
285B-6	80157233	1" □	2,400	1,220	5,000	700	12.60	519	1/2 NPT	13	4.7	17.50	99.8	9.0/2.7
285B	80157209	1" □	2,400	1,220	5,000	700	11.20	360	1/2 NPT	13	4.7	17.50	99.8	8.0/1.2

⁽¹⁾ ISO28927 – 3-axis measurement: vibration level/measurement uncertainty.
Performance at 6.2 bar (90 psi)

Air Impact Wrenches | 1" (pistol and rear angle)

2175MAX

1" ■ Short anvil



- 2715 Nm of Max Reverse Torque
- Twin Hammer mechanism
- Built in auto lubrication system
- Ready for exhaust connection
- 2-Years Warranty

Also available

2175MAX-6

Long anvil 150 mm

295A

1" ■ Short anvil



- Designed for operation at 8.3 bar dynamic (120 psi)
- 2,400 Nm
- Swinging-hammer impact mechanism
- 3-position power regulator

Also available

295A-6

Long anvil 150 mm

Protection Boot

295-BOOT

CCN: 45505484

2171XP

1" ■ Short anvil



- 1,695 Nm
- Only 5.47 kg (2171XP)
- Twin-hammer impact mechanism
- Steel hammer case
- 3-position power regulator

Protection Boot

2161-BOOT

CCN: 45505401

Air Impact Wrenches | 1" (pistol and rear angle)

2155QiMAX

1" ■ Short anvil



- 1,830 Nm of maximum torque in reverse
- Ergonomic composite housing is lightweight, protects from cold air and offers great operator comfort
- The low weight of this tool will reduce operator fatigue
- 360° swivel inlet helps eliminating twisted hoses
- Two-year warranty

Protection Boot

2145M-BOOT

CCN: 48385033

271

1" ■ Short anvil



- 1,491 Nm
- Jumbo-hammer impact mechanism
- Steel hammer case
- 5-position power regulator

Ref.	CCN	in	Nm	Nm	rpm	bpm	kg	mm	in	mm	l/s	l/s	dB(A)	m/s ² /K ⁽¹⁾
2175MAX	2175MAX	1" □	2,715	2,170	4,500	740	8.2	254	1/2 NPT	19 mm	6.7	26.8	101.5	11.8/3.6
2175MAX-6	2175MAX-6	1" □	2,715	2,170	4,500	740	9.1	406	1/2 NPT	19 mm	6.7	26.8	101.5	11.2/3.4
295A	80159015	1" □	2,400	1,220	5,000	700	9.98	290	1/2 NPT	13	4.7	17.50	97.0	8.6/1.0
295A-6	16578734	1" □	2,400	1,220	5,000	700	11.40	449	1/2 NPT	13	4.7	17.50	97.0	9.1/2.9
2171XP	01378165	1" □	1,695	1,356	6,000	1,025	5.47	226	3/8 NPT	13	4.7	21.50	94.7	10.3/1.3

⁽¹⁾ ISO28927 – 3-axis measurement: vibration level/measurement uncertainty.

Performance at 6.2 bar (90 psi)

Ref.	CCN	in	Nm	Nm	rpm	bpm	kg	mm	in	mm	l/s	l/s	dB(A)	m/s ² /K ⁽¹⁾
2155QiMAX	47123450	1" □	1,830	1,220	6,300	1,150	3.36	225	3/8 NPT	13	4.0	15.10	96.3	8.7/2.7
271	01209766	1" □	1,491	1,224	5,500	1,000	5.67	226	3/8 NPT	13	4.5	17.90	98.1	13.2/1.1

⁽¹⁾ ISO28927 – 3-axis measurement: vibration level/measurement uncertainty.

Performance at 6.2 bar (90 psi)

Sockets Features

Genuine Ingersoll Rand impact sockets are built of top-quality materials for performance and durability.



Our sockets come with a lifetime warranty. Specifically designed for use with Ingersoll Rand power tools, our sockets are the perfect solution for your everyday tightening and loosening applications.

PowerSocket™

Get up to 50% More Power*

Even when facing the toughest crank bolt or a frozen or rusted lug nut, you won't need to switch to a bigger tool or breaker bar! Because the PowerSocket™ adds the torque you need to your favorite 1/2" impact wrench. It allows you to remove the most difficult fastener after just a few blows, getting the job done quickly.

Thanks to its revolutionary, patent-pending power ring design, PowerSockets™ provide up to 50% more torque* with your 1/2" impact wrench. Built to the same standards



as our professional-grade impact sockets, they are made to last and work as hard as you.

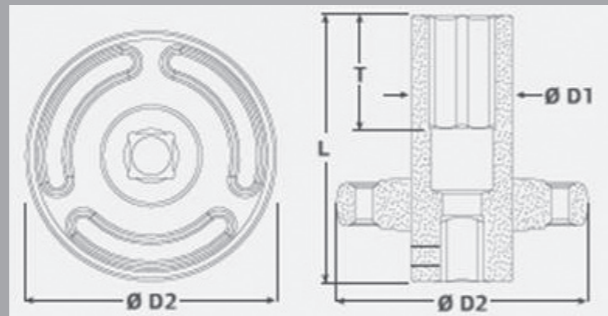

Part Number	CCN	Output Size	Weight kg	D1 mm	D2 mm	T mm	L mm
6-PT PowerSocket™							
S64M17L-PS1	47539801001	17 mm	0.56	30.7	72.6	28.5	78
S64M18L-PS1	47569349001	18 mm	0.56	31.2	72.6	33.7	78
S64M19L-PS1	47539800001	19 mm	0.55	31.4	72.6	34.3	78
S64M21L-PS1	47539802001	21 mm	0.58	34.2	72.6	32.5	78
S64M22L-PS1	47569350001	22 mm	0.64	35.8	72.1	30.3	78
S64M24L-PS1	47569351001	24 mm	0.67	38.2	72.1	30.3	78
S64M26L-PS1	47539803001	26 mm	0.69	39.6	72.1	33.0	78
S64M27L-PS1	47539804001	27 mm	0.71	41.1	72.1	35.7	78

SK2M12

1/4" Square Drive Socket Set
CCN: 81287336



- Contains 9 standard sockets: 6, 7, 8, 9, 10, 11, 12, 13 and 14 mm
- 50 and 100 mm extensions, 3/4" F x 1/4" M adapter

SK3M8N

3/8" Square Drive Socket Set
CCN: SK3M8N



- Contains 8 standard sockets: 9, 10, 11, 13, 14, 15, 17 and 19 mm

SK4M14N

1/2" Square Drive Socket Set
CCN: SK4M14N



- Contains 14 standard sockets: 10, 11, 12, 13, 14, 15, 16, 17, 18, 19, 21, 22, 26 and 27 mm

SK4M18N

1/2" Square Drive Socket Set
CCN: SK4M18N



- Contains 9 standard sockets: 10, 11, 13, 14, 17, 19, 21, 22 and 24 mm
- 4 deep sockets 13, 14, 21 and 24 mm
- 3 deep/thin wall sockets 17, 19 and 21 mm
- 150mm extension bar and 1/2" square drive power joint

SK4M3LN

1/2" Square Drive Socket Set
CCN: SK4M3LN



- Contains 3 deep insulated thin wall sockets: 17, 19 and 21 mm

SK4M7UN

1/2" Square Drive Socket Set
CCN: SK4M7UN



- Contains 7 universal sockets: 13, 14, 15, 17, 19, 21 and 22 mm
- Pre-fitted power joint – to facilitate handling nuts and bolts in areas with very limited accessibility

SK4M5LN

1/2" Square Drive Socket Set
CCN: SK4M5LN



- Contains 15 deep sockets: 17, 19, 21, 22 and 24 mm

SK6M6LN

3/4" Square Drive Socket Set
CCN: SK6M6LN



- Contains 6 deep sockets: 24, 27, 30, 32, 33 and 36 mm

SK8M4LN

1" Square Drive Socket Set
CCN: SK8M4LN



- Contains 4 long sockets: 27, 30, 32 and 33 mm

Impact Socket Extensions



	Square drive	Length (mm)	Recommended retaining ring
E24H	1/4"	100	-
E26H	1/4"	150	-
E33H	3/8"	75	RR10003
E36H	3/8"	150	RR10003
E312H	3/8"	300	RR10003
E43H	1/2"	75	RR10006
E45H	1/2"	125	RR10006
E47H	1/2"	175	RR10006
E410H	1/2"	250	RR10006
E424H	1/2"	600	RR10006

	Square drive	Length (mm)	Recommended retaining ring
E63H	3/4"	75	RR10034S
E67H	3/4"	175	RR10034S
E610H	3/4"	250	RR10034S
E83H	1"	75	RR10015S
E87H	1"	175	RR10015S
E810H	1"	250	RR10015S
E813H	1"	330	RR10015S

Universal Joints

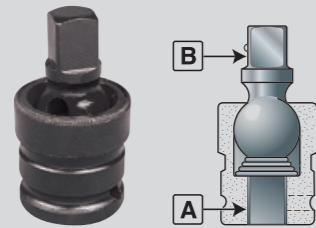

Universal Joint

	A (mm)	B (mm)	Recommended retaining ring
J2	1/4"	1/4"	-
J3	3/8"	3/8"	-
J4	1/2"	1/2"	-
J6	3/4"	3/4"	RR10034S
J8	1"	1"	RR10015S

Adapters

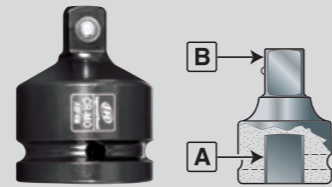

	A (mm)	B (mm)	Recommended retaining ring
A2F3M	1/4"	3/8"	-
A3F2M	3/8"	1/4"	RR10003
A3F4M	3/8"	1/2"	RR10003
A4F3M	1/2"	3/8"	RR10006
A4F6M	1/2"	3/4"	RR10008
A6F4M	3/4"	1/2"	RR10034S
A6F8M	3/4"	1"	RR10034S
A8F6M	1"	3/4"	RR10015S



A: Tune-up kit
B: Hammer mechanism kit

	A	B
1/4" and 3/8"	CCN	CCN
1105MAX-D2	45668456	45668522
105-D2	45668142	45668522
2115QTiMAX	45585189	45585932
2115QXPA	45585189	45585932
15QMAX	4762155001	47562154001
212	03866522	-
211	03866449	-
LA158	49827108	49827090
109XPA	16594160	16594384
107XPA	80146491	16590416
1207MAX-D3	47085931	47086368
1105MAX-D3	45668456	45668563
105-D3	45668142	45668563
1/2"	CCN	CCN
36QMAX	4762155001	47562154001
2135QXPA	45535028	80119571
2135QXPA-2	45535028	80119662
2235QXPA	47517401001	47517319001
2235QTiMAX	47517401001	47517319001
2235QTiMAX-2	47517401001	47517319001
2130XP	80142375	80140528
1099XPA	16594160	16594392
1077XPA	80146491	16590424
1770	-	80147077
2125QTiMAX	45585189	45585932
2025MAX	47100474	47100359

	A	B
3/4"	CCN	CCN
2145QiMAX	47100011	47102561
2145QiMAX-3	47100011	47102561
2145QiMAX-6	47100011	47102561
2161XP	04621744	-
2161XP-6	04621744	-
261	03866597	22039259
261-3	03866597	-
261-6	03866597	-
259	45663796	45663853
1" pistol	CCN	CCN
2175MAX	47629423001	47584530001
2175MAX-6	47629423001	47584530001
295A	16590242	-
295A-6	16590242	-
2155QiMAX	47100011	47102561
2171XP	04621744	80137698
2171XP-6	04621744	80137714
271	03866597	-
1" rear handle	CCN	CCN
631L	45766789	-
2850MAX	47584534001	47584530001
2850MAX-6	47584534001	47584530001
2190Ti-6	80137383	80137714
280-EU	03866605	-
280-6-EU	03866605	-
285B	16578965	-
285B-6	16578965	-

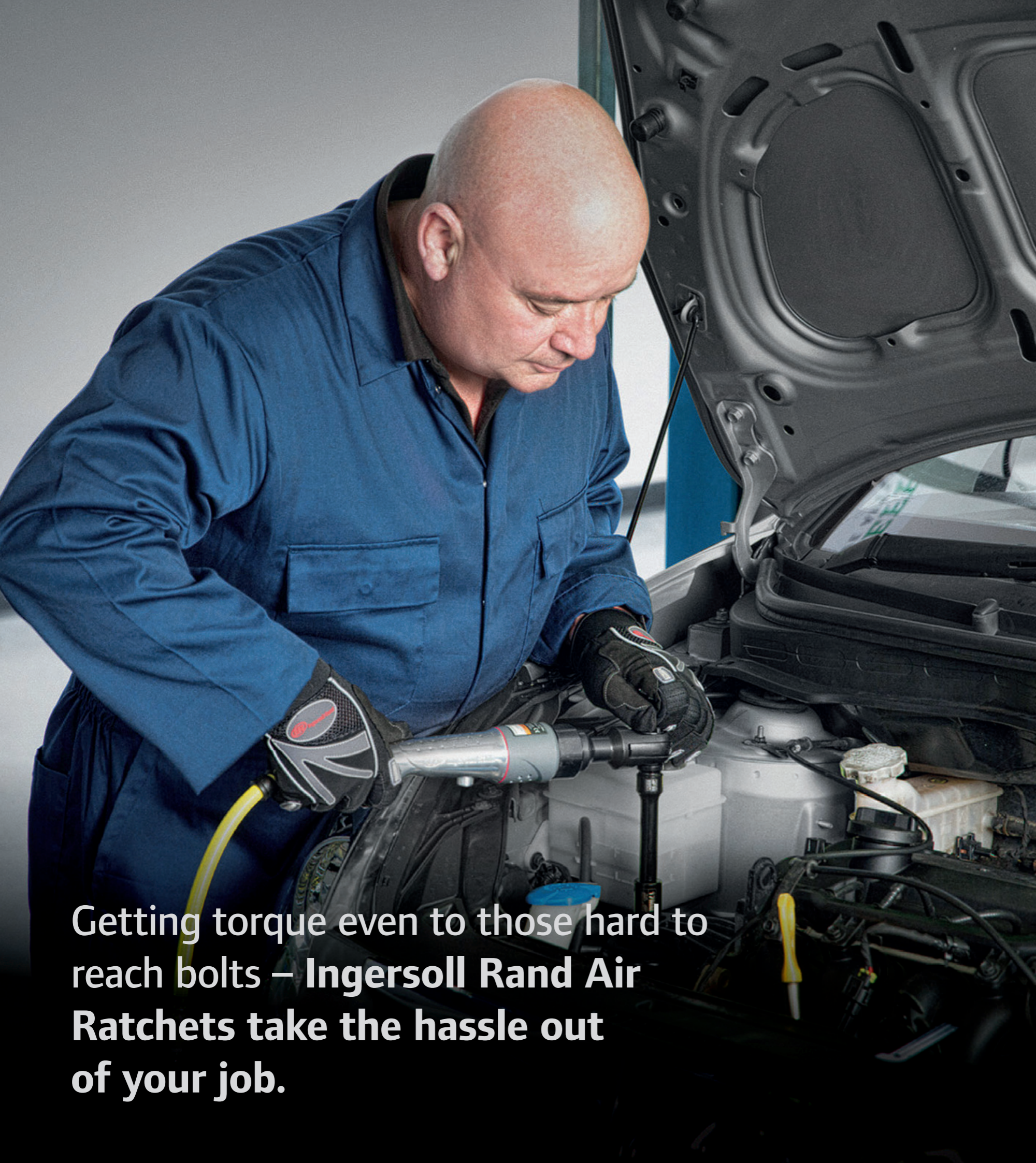

Getting torque even to those hard to reach bolts – Ingersoll Rand Air Ratchets take the hassle out of your job.

Air Ratchets

36 | 1/2"

37 | 3/8"

37 | 1/4"

When Mies van der Rijn has a job to do, he wants to get it done. Loosening and tightening nuts and bolts has to feel natural to him, even in the most remote nook or corner. With the excellent ergonomic and versatility of Ingersoll Rand's compact ratchets, he has found a forceful partner for life.

Mies van der Rijn, Rotterdam

Air Ratchets



1099XPA 1/2" ■

- 103 Nm and 220 rpm
- Variable speed lever
- 360° adjustable exhaust



Also available
109XPA
3/8"

Air Ratchets | 1/4" | 3/8" | 1/2"

1105MAX-D3 3/8" ■



- 41 Nm and 300 rpm
- Only 0.65 kg and 187 mm
- Composite housing
- Power regulator
- Variable speed lever

Also available
1105MAX-D2
1/4"

Protection Boot
103-BOOT
CCN: 45505310

1207MAX-D4 1/2" ■



- 88 Nm and 200 rpm
- Composite housing
- Power regulator
- Variable speed lever
- 360° adjustable exhaust

Also available
1207MAX-D3
3/8"

1077XPA 1/2" ■



- 73 Nm and 160 rpm
- Variable speed lever
- 360° adjustable exhaust

Also available
107XPA
3/8"

Protection Boot
107-BOOT
CCN: 45505328

105-D3 3/8" ■



- 34 Nm and 250 rpm
- Only 0.64 kg and 186 mm
- Variable speed lever

Also available
105-D2
1/4"

Protection Boot
103-BOOT
CCN: 45505310

1770 1/2" ■



- 81 Nm of maximum torque
- Heat-treated head provides exceptional durability
- Variable speed lever allows precise delivery of power

Also available
170
3/8"

Ref.	CCN	in	Nm	Nm	rpm	kg	mm	in	mm	l/s	l/s	dB(A)	m/s ² /K ⁽¹⁾
1099XPA	80181001	1/2" □	103	87	220	1.51	306	1/4 NPT	10	1.9	11.30	92.4	2.5/0.7
109XPA	16578700	3/8" □	103	87	220	1.50	306	1/4 NPT	10	1.9	11.30	92.4	2.5/0.7

⁽¹⁾ ISO28927 – 3-axis measurement: vibration level/measurement uncertainty.

Ref.	CCN	in	Nm	Nm	rpm	kg	mm	in	mm	l/s	l/s	dB(A)	m/s ² /K ⁽¹⁾
1105MAX-D3	45649480	3/8" □	41	34	300	0.65	187	1/4 NPT	10	1.6	9.40	88.9	5.7/1.0
1105MAX-D2	45649035	1/4" □	41	34	300	0.65	187	1/4 NPT	10	1.6	9.40	88.9	5.7/1.0
1207MAX-D4	45654225	1/2" □	88	81	200	1.45	275	1/4 NPT	10	1.9	10.80	85.0	3.2/1.1
1207MAX-D3	45643276	3/8" □	88	81	200	1.45	275	1/4 NPT	10	1.9	10.80	85.0	3.2/1.1
1077XPA	80171853	1/2" □	73	61	160	1.25	276	1/4 NPT	10	1.9	8.80	94.4	< 2.5
107XPA	80171705	3/8" □	73	61	160	1.24	276	1/4 NPT	10	1.9	8.80	94.4	< 2.5
105-D3	45649738	3/8" □	34	27	220	0.64	186	1/4 NPT	10	1.4	8.50	81.8	5.1/0.9
105-D2	45649571	1/4" □	34	27	220	0.64	186	1/4 NPT	10	1.4	8.50	81.8	5.1/0.9
1770	80103799	1/2" □	81	81	160	1.17	262	1/4 NPT	10	1.9	10.00	94.8	2.8/0.7
170	80103781	3/8" □	81	81	160	1.16	262	1/4 NPT	10	1.9	10.00	94.8	2.8/0.7

⁽¹⁾ ISO28927 – 3-axis measurement: vibration level/measurement uncertainty.



Air Grinders

40 | Die Grinders

43 | Wheel Grinders

Impressive performance and ultimate precision – The throttle of Ingersoll Rand air grinders really puts you in the driver's seat.

With the sheer power a grinder needs, control is of the essence for Tomasz Głacz. Because he always aims for maximum precision. Working with a compact, lightweight Ingersoll Rand grinder, he hasn't only come to love the handling but also is a good deal more efficient.

Tomasz Głacz, Krakow

Air Grinders



5102MAX Angle



- 0.30 kW
- 20,000 rpm
- Only 0.64 kg and 178 mm
- Composite housing
- Contains: 1/4" and 6 mm collets

Also available 5108MAX Straight



- 0.30 kW
- 20,000 rpm
- Only 0.64 kg and 178 mm
- Composite housing
- Contains: 1/4" and 6 mm collets

Ref.	CCN	mm	kWatt	rpm	kg	mm	in	mm	l/s	l/s	dB(A)	m/s ² /K ⁽¹⁾
5102MAX	48488357	1/4" + 6	0.30	20,000	0.64	180	1/4 NPT	10	2.8	11.80	84.1	3.3/1.1
5108MAX	48488340	1/4" + 6	0.30	25,000	0.46	172	1/4 NPT	10	2.8	11.80	83.3	1.8/0.8

⁽¹⁾ ISO28927 – 3-axis measurement: vibration level/measurement uncertainty.

Air Grinders | Die Grinders

308B Straight



- 0.25 kW
- 25,000 rpm
- Only 0.46 kg and 172 mm
- Contains: 1/4" and 6 mm collets

302B Angle



- 0.25 kW
- 20,000 rpm
- Only 0.58 kg and 175 mm
- Contains: 1/4" and 6 mm collets

307B Straight



- 0.19 kW
- 28,000 rpm
- Only 0.33 kg and 125 mm
- Contains: 1/4" and 6 mm collets

Ref.	CCN	mm	kWatt	rpm	kg	mm	in	mm	l/s	l/s	dB(A)	m/s ² /K ⁽¹⁾
308B	48488332	1/4" + 6	0.25	25,000	0.46	172	1/4 NPT	10	3.3	13.20	92.0	3.7/1.2
302B	48488365	1/4" + 6	0.25	20,000	0.58	175	1/4 NPT	10	2.8	10.80	90.0	5.5/1.5
307B	48488316	1/4" + 6	0.19	28,000	0.33	125	1/4 NPT	10	2.8	11.30	83.0	4.5/1.1

⁽¹⁾ ISO28927 – 3-axis measurement: vibration level/measurement uncertainty.

Air Grinders | Die Grinders

301B Angle



- 0.19 kW
- 21,000 rpm
- Only 0.46 kg and 128 mm
- Contains: 1/4" and 6 mm collets

Replacement collets



Ref.	CCN	diameter
Collets for 301B, 302B, 307B, 308B, 5102MAX, 5108MAX and LA429-EU		
301-700C	80128952	Ø 1/8"
301-700B	04552600	Ø 6 mm
301-700	80102346	Ø 1/4"

LA429-EU Straight



- 0.42 kW
- 20,000 rpm
- Only 0.54 kg
- Contains: 1/4" and 6 mm collets

Air Grinders | Wheel Grinders

345MAX-M 125 mm (5")



- 0.66 kW
- 12,000 rpm
- Speed governor
- Composite housing
- Piped-away exhaust system

Also available
3445MAX-M
115 mm (4.5")

LA422-EU 125 mm (5")



- 0.50 kW
- 12,000 rpm

Also available
LA421-EU
100 mm (4")

Ref.	CCN	mm	mm	kWatt	rpm	kg	mm	in	mm	l/s	l/s	dB(A)	m/s ² /K ⁽¹⁾
345MAX-M	45664257	125	M14	0.66	12,000	1.56	245	1/4 NPT	10	4.9	19.30	79.6	7.9/0.7
3445MAX-M	45664240	115	M14	0.66	12,000	1.53	245	1/4 NPT	10	4.9	19.30	79.6	6.4/2.0
LA422-EU	01328582	125	3/8" - 24	0.50	12,000	1.75	229	1/4 NPT	10	2.8	10.40	85.6	6.0/2.1
LA421-EU	01328632	100	3/8" - 24	0.50	12,000	1.75	229	1/4 NPT	10	2.8	10.40	85.6	4.8/1.4

⁽¹⁾ ISO28927 – 3-axis measurement: vibration level/measurement uncertainty.

Ref.	CCN	mm	kW	rpm	kg	mm	in	mm	l/s	l/s	dB(A)	m/s ² /K ⁽¹⁾
301B	48488308	1/4" + 6	0.19	21,000	0.46	128	1/4 NPT	10	2.8	11.30	91.8	5.9/1.0
LA429-EU	01328558	1/4" + 6	0.42	22,000	0.54	142	1/4 NPT	10	1.8	9.00	91.0	3.2/1.7

⁽¹⁾ ISO28927 – 3-axis measurement: vibration level/measurement uncertainty.



For all to whom finishing is an art form – Ingersoll Rand gives you perfect grip and the perfect tool, for whatever purpose.

Air Finishing Tools

46 | Air Sanders and Polishers

49 | Pads, Disks and Bonnets

For Mustafa Belkhoda, perfect body work starts with a perfect finish. Smooth, swirl free surfaces are an accomplishment he prides himself on. Ingersoll Rand's sanders fit his hand like a glove, giving his work a sophistication that leaves him with a proud smile at the end of every day.

Mustafa Belkhoda, Chartres

Air Finishing Tools



4151-HL
150 mm (6"), orbit 5 mm (3/16")



- 0.15 kW (0.20 HP)
- 12,000 rpm
- Only 0.86 kg
- Composite Housing
- Auto-Balancer
- Power regulator

Also available

- 4152-HL**
150 mm (6"), orbit 2.5 mm (3/32")
- 4151-HL-2**
150 mm (6"), orbit 5 mm (3/16")

Ref.	CCN	mm	mm	mm	kWatt	rpm	kg	mm	in	mm	l/s	l/s	dB(A)	m/s ² /K ⁽¹⁾
4151-HL	1371624	150	5.00	5/16" - 24	0.15	12,000	0.86	190	1/4 NPT	8	3.7	7.20	81.6	7.5/1.6
4151-HL-2	22041198	150	5.00	5/16" - 24	0.15	12,000	1.12	252	1/4 NPT	8	3.7	7.20	81.6	6.2/1.0
4152-HL	80134356	150	2.50	5/16" - 24	0.15	12,000	0.86	190	1/4 NPT	8	3.7	7.20	81.6	8.2/1.7

⁽¹⁾ ISO28927 – 3-axis measurement: vibration level/measurement uncertainty.

Air Finishing tools | Air Sanders and Polishers

3103XPA
Sander - Tool only



- 50 mm (2") and 75 mm (3")
- 0.15 kW (0.2 HP)
- 15,000 rpm
- Only 0.50 kg and 135 mm
- Composite housing
- 2-position power regulator

Available in kits
3103KA Kit
CCN: 47520769001



Includes 14-piece 2" (50mm) and 3" (75mm) sanding discs and pads

3128XPA
RO Sander - Tool only



- 75 mm (3")
- Orbit 5 mm (3/16")
- 0.15 kW (0.2 HP)
- 15,000 rpm
- Only 0.60 kg and 145 mm
- Composite housing
- 2-position power regulator

Available in kits
3128KA Kit
CCN: 47520770001



Includes 71-piece hook and loop discs and pad: - 180, 220, 320 and 800 grits aluminum oxide - backing pad

3129XPA
Polisher - Tool only



- 75 mm (3")
- 0.22 kW (0.30 HP)
- 6,400 rpm
- Only 0.60 kg and 155 mm
- Composite housing
- 2-position power regulator

Available in kits
3129KA Kit
CCN: 47520771001



Includes four-piece hook and loop pads with foams

Ref.	CCN	mm	mm	kWatt	rpm	kg	mm	in	mm	l/s	l/s	dB(A)	m/s ² /K ⁽¹⁾
3103XPA	47520748001	50 and 75	-	0.15	15,000	0.50	135	1/4 NPT	10	9.0	0.00	78.6	4.1/0.8
3128XPA	47520749001	75	5.00	0.15	15,000	0.60	145	1/4 NPT	10	8.6	0.00	80.9	5.2/1.1
3129XPA	47520750001	75	-	0.22	6,400	0.60	155	1/4 NPT	10	9.4	0.00	81.5	2.7/0.7

⁽¹⁾ ISO28927 – 3-axis measurement: vibration level/measurement uncertainty.

Air Finishing tools | Air Sanders and Polishers

311A

150 mm (6"), orbit 5 mm (3/16")



- 150 mm (6")
- Orbit: 5 mm (3/16")
- 10,000 rpm
- Power regulator

313A

Tool only



- 180 mm (7")
- 0.37 kW (0.5 HP)
- 5000 rpm

Also available

314A

2,500 rpm

312A

93 x 171 mm (3.67 x 6.75")

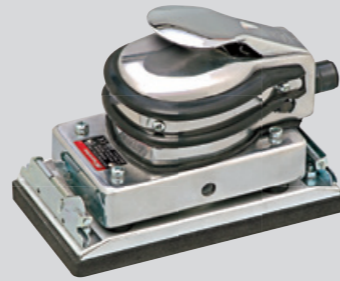

- 0.22 kW (0.30 HP)
- 8,000 strokes per minute

Also available

315-EU

70 x 445 mm (2,75 x 17,5")

3,000 strokes per minute

317A

75 mm (3") and 125 mm (5")



- 75 mm and 125 mm
- 0.35 kW (0.45 HP)
- 18,000 rpm
- Power regulator

318A

Tool only



- 180 mm (7")
- 0.6 kW (0.8 HP)

Also available

319A

5,000 rpm

Ref.	CCN	mm	mm	kWatt	rpm	kg	mm	in	mm	l/s	l/s	dB(A)	m/s ² /K ⁽¹⁾
311A	01365253	150	5/16" - 24	0.19	10,000	1.90	248	1/4 NPT	10	8.0	11.80	84.3	32.3/5.6
317A	80090863	125	7/16" - 20	0.35	18,000	1.05	104	1/4 NPT	10	5.7	11.80	86.7	3.3/0.8
313A	80141021	180	5/8" - 11	0.37	5,000	2.04	406	1/4 NPT	10	3.8	13.70	88.0	< 2.5
314A	80141039	180	5/8" - 11	0.37	2,500	1.90	406	1/4 NPT	10	3.8	13.70	87.0	< 2.5
318A	80141047	180	-	0.60	2,800	2.05	203	1/4 NPT	10	2.8	9.90	85.0	< 2.5
319A	80141054	180	5/8" - 11	0.60	5,000	2.05	203	1/4 NPT	10	2.8	9.90	85.0	< 2.5
312A	80147101	93 x 171	-	0.22	8,000	2.09	171	1/4 NPT	10	4.3	5.70	86.0	7.7/1.5
315-EU	1343961	70 x 445	-	-	3,000	2.77	445	1/4 NPT	10	3.8	4.30	93.3	20.5/1.6

⁽¹⁾ ISO28927 - 3-axis measurement: vibration level/measurement uncertainty.

Air Finishing tools | Pads, Disks and Bonnets

Quick-change pads & abrasives 50 (2") and 75 mm (3")



Hook-and-loop pad, discs & bonnets 75 mm (3")



Accessories for 4151 and 4152



Ref.	CCN	Description	Qty.
50 mm (2") Diameter			
02A-MEDPD	80199177	Quick-change pad with 1/4" mandrel	1
02A-CRSBR	80199193	Coarse coating removal discs	1
02A-MEDBR	80199185	Medium coating removal discs	1
02A-BBCRS-25	80207574	Quick-strip discs	25
02A-036AO	80199896	Aluminum oxide sanding discs, grit 36	1
02A-036AO	80199201	Aluminum oxide sanding discs, grit 80	1
75 mm (3") Diameter			
03A-MEDPD	80198963	Quick-change pad with 1/4" mandrel	1
03A-CRSBR	80199037	Coarse coating removal discs	1
03A-MEDBR-25	80206220	Medium coating removal discs	25
03A-CRSBB-10	80216690	Quick-strip discs	10
03A-036AO	80200009	Aluminum oxide sanding discs, grit 36	1
03A-080AO5	80199219	Aluminum oxide sanding discs, grit 80	1
Backer pad			
03H-PAD-HL	80199136	Backer pad Ø 75 mm (3 in), hook & loop	1
Aluminum oxide sanding discs			
03H-040AO-50	80207582	Grit 40	50
03H-100AO-50	80206279	Grit 100	50
03H-180AO-50	80206295	Grit 180	50
03H-220AO-50	80206303	Grit 220	50
03H-320AO-50	80206329	Grit 320	50
03H-500AO-50	80206352	Grit 500	50
03H-800AO-50	80205404	Grit 800	50
Polishing Bonnets			
03F-SFTWL-6	80206170	Wool bonnet (for compounding)	6
03F-MEDFM-6	80206188	Waffle bonnet/white (for compounding)	6
03F-SFTFM-6	80206196	Waffle bonnet/yellow (for polishing)	6
Accessories for 4151 and 4152			
4151JV	04662896	Jet-Vac conversion kit	
49988	04324455	Dust collection bags (20 pieces)	
49987	04324448	Dust collection bags (250 pieces)	
4151-747B	80095151	Rubber grip	
4151-2-747BLK	22041941	Rubber grip, long handle	
49798	04248555	Rubber grip, medium	
49799	04248563	Rubber grip, large	
49840	04252938	Rubber grips (3 pieces: small, medium and large)	



When hard-hitting meets minor effort – reduce your strain and save energy for a variety of jobs within the workshop.

Air Hammers

- 52 | Round Shank
- 53 | Needle Scaler
- 53 | Accessories

Enzo Buonpensa has never cut, punched, chipped, scraped, or worked on exhaust more conveniently and swiftly. The intelligent design of the robust Ingersoll Rand Air Hammer makes it indispensable especially for extended use. That's why the new tool has really paid off quickly for him.

Enzo Buonpensa, Turin

Air Hammers



118MAX

Round shank



- Stroke: 89 mm
- 2,500 blows per minute
- Contains: quick-change retainer

Also available
118MAXH
Hexagonal shank

Available in kits

118MAXK Round shank
CCN: 47125877

118MAXHK Hexagonal shank
CCN: 46816765



Hammer + Quick-Change Retainer and 5 Chisels

Ref.	CCN	bpm	mm	kg	mm	in	mm	l/s	l/s	dB(A)	m/s ² /K ⁽¹⁾
118MAX	47124490	2,500	89	2.10	314	1/4 NPT	10	1.4	5.50	92.6	4.0/1.4
118MAXH	46816732	2,500	89	2.10	314	1/4 NPT	10	1.4	5.50	92.6	4.0/1.4

⁽¹⁾ ISO28927 – 3-axis measurement: vibration level/measurement uncertainty.

Air Hammers | Round Shank | Needle Scaler | Accessories

122MAX

Round shank



- Stroke: 67 mm
- 3,500 blows per minute
- Contains: quick-change retainer

Also available

122MAXH
Hexagonal shank

Available in kits

122MAXK Round shank
CCN: 47125869

122MAXHK Hexagonal shank
CCN: 46816757



Hammer + Quick-Change Retainer and 5 Chisels

121/Q-EU

Round shank



- Stroke: 58 mm
- 3,000 blows per minute

Also available

121/QH-EU
Hexagonal shank

125-EU

Needle Scaler



- Stroke: 28 mm
- 4,600 blows per minute
- Contains: steel needles

116-EU

Round shank



- Stroke: 67 mm
- 3,500 blows per minute
- Power regulator

Also available

116H-EU
Hexagonal shank

Available in kits

LA426-EU Round shank
CCN: 01328640

LA427-EU Hexagonal shank
CCN: 01328590



Hammer + 6 Chisels

Air Hammers | Accessories

- **115-183** (CCN: 03788510) spring retainer for 116-EU, 116H-EU, LA426-EU and LA427-EU
- **AVC10-183** (CCN: 03010980) spring retainer for 121/Q-EU and 121/QH-EU
- **9512** (CCN: 45563749) quick-change retainer for all models
- **9500** (CCN: 80117427) chisels, round shank (5 pieces)
- **116H-K5** (CCN: 92536093) chisels, hexagonal shank (5 pieces)



115-183



9512



9500

Ref.	CCN	bpm	mm	kg	mm	in	mm	l/s	l/s	dB(A)	m/s ² /K ⁽¹⁾
122MAX	47124482	3,500	67	1.80	218	1/4 NPT	10	1.4	5.50	94.2	5.5/1.8
122MAXH	46816740	3,500	67	1.80	218	1/4 NPT	10	1.4	5.50	94.2	5.5/1.8
121/Q-EU	01343698	3,000	58	1.59	194	1/4 NPT	10	1.4	7.10	95.3	19.9/4.6
121/QH-EU	01344944	3,000	58	1.59	194	1/4 NPT	10	1.4	7.10	95.3	19.9/4.6
125-EU	01352178	4,600	29	2.83	465	1/4 NPT	8	3.8	7.10	96.6	8.3/1.3
116-EU	01343755	3,500	67	1.54	198	1/4 NPT	10	1.4	7.10	101.4	14.8/2.2
116H-EU	01343904	3,500	67	1.54	198	1/4 NPT	10	1.4	7.10	101.4	14.8/2.2

⁽¹⁾ ISO28927 – 3-axis measurement: vibration level/measurement uncertainty.



For Ingersoll Rand, durability is key – because a tool becomes an extension to the hand.

Air Drills, Screwdrivers and Specialty Tools

- 56 | Drills
- 58 | Screwdrivers
- 59 | Specialty Tools (incl. cutting tools)

When the going gets tough, Knut Paulsen gets his toughest tools going. And these are his Ingersoll Rand Air Drills and Screwdrivers. Having counted on them for all purposes for years, he knows a thing or two about them: being virtually indestructible they are in high demand in the shop and best kept in the top shelf right next to him.

Knut Paulsen, Hamburg

Air Drills, Screwdrivers and Specialty Tools



7804XPA
Standard chuck, reversible



- 6.5 mm (1/4 in)
- 0.12 kW (0.17 HP)
- 1,600 rpm
- Only 0.8 kg and 180 mm
- Composite housing
- Reversible

Available in kits
7804KA Standard chuck, reversible
CCN: 47520772001



Includes 22-piece drill bit and driver set

Ref.	CCN	SIZE mm	kWatt kW	1 min rpm	kg	L mm	in	mm	l/s	MAX l/s	dB(A)	m/s ² /K ⁽¹⁾
7804XPA	47520751001	10	0.19	1,875	0.80	193	1/4 NPT	10	0.9	7.65	84.3	2.9/0.8

⁽¹⁾ ISO28927 – 3-axis measurement: vibration level/measurement uncertainty.

Air Drills, Screwdrivers and Specialty Tools | Drills

7803A
Standard chuck



- 13 mm (1/2 in) chuck
- 0.37 kW (0.50 HP)
- 500 rpm

Also available
7803AKC
Keyless chuck
7803RA
Standard chuck, reversible
7803RAKC
Keyless chuck, reversible

Protection Boot
7803-BOOT
CCN: 45524287

7802A
Standard chuck



- 10 mm (3/8 in) chuck
- 0.37 kW (0.50 HP)
- 2,000 rpm

Also available
7802AKC
Keyless chuck
7802RA
Standard chuck, reversible
7802RAKC
Keyless chuck, reversible

Protection Boot
7802-BOOT
CCN: 45524279

7807R-EU
Standard chuck, reversible



- 10 mm (3/8 in) standard chuck
- 0.25 kW (0.33 HP)
- 2,000 rpm
- Reversible

LA410-EU
Standard chuck



- 10 mm (3/8 in) standard chuck
- 0.25 kW (0.33 HP)
- 4,500 rpm

Ref.	CCN	SIZE mm	kWatt kW	1 min rpm	kg	L mm	in	mm	l/s	MAX l/s	dB(A)	m/s ² /K ⁽¹⁾
7803A	80113632	13	0.37	500	1.63	195	1/4 NPT	10	1.9	12.70	83.0	< 2.5
7803AKC	10563724	13	0.37	500	1.63	200	1/4 NPT	10	1.9	12.70	83.0	< 2.5
7803RA	80113673	13	0.37	500	1.64	195	1/4 NPT	10	1.9	12.70	83.0	< 2.5
7803RAKC	10563732	13	0.37	500	1.64	200	1/4 NPT	10	1.9	12.70	83.0	< 2.5
7802A	80113616	10	0.37	2,000	1.31	163	1/4 NPT	10	1.9	12.30	83.0	2.8/0.7
7807R-EU	01352160	10	0.25	1,800	1.07	206	1/4 NPT	10	1.9	8.10	89.2	< 2.5
7802AKC	10563716	10	0.37	2,000	1.35	175	1/4 NPT	10	1.9	12.30	83.0	2.8/0.7
7802RA	80113640	10	0.37	2,000	1.30	163	1/4 NPT	10	1.9	12.30	83.0	2.8/0.7
7802RAKC	80147424	10	0.37	2,000	1.36	175	1/4 NPT	10	1.9	12.30	83.0	2.8/0.7
LA410-EU	01328616	10	0.25	4,500	0.91	228	1/4 NPT	10	1.4	12.80	84.9	2.9/0.7

⁽¹⁾ ISO28927 – 3-axis measurement: vibration level/measurement uncertainty.

Air Drills, Screwdrivers and Specialty Tools | Screwdrivers

LA439-EU
1/4" Hexagonal



- 13 Nm
- 0.25 kW
- 1,800 rpm
- Adjustable clutch
- 1-hand forward and reverse switch

LA412-EU
1/4" Hexagonal



- 13 Nm
- 0.25 kW
- 1,800 rpm
- Positive jaw clutch
- 1-hand forward and reverse switch

371-EU
1/4" Hexagonal



- 13 Nm
- 0.25 kW
- 1,800 rpm
- Positive jaw clutch
- 1-hand forward and reverse switch

LA413-EU
1/4" Hexagonal



- 13 Nm
- 0.25 kW
- 1,800 rpm
- Adjustable clutch
- 1-hand forward and reverse switch

Ref.	CCN	in	kWatt	1 min rpm	kg	mm	in	mm	l/s	l/s	dB(A)	m/s ² /K ⁽¹⁾
LA439-EU	01330133	1/4" ♂	0.25	1,800	1.10	216	1/4 NPT	10	1.4	13.70	89.9	< 2.5
LA412-EU	01330075	1/4" ♂	0.25	1,800	1.60	184	1/4 NPT	10	1.9	13.70	89.6	< 2.5
371-EU	01352152	1/4" ♂	0.25	1,800	1.14	188	1/4 NPT	10	1.9	10.20	91.0	< 2.5
LA413-EU	01330109	1/4" ♂	0.25	1,800	1.50	260	1/4 NPT	10	1.4	8.00	109.2	< 2.5

⁽¹⁾ ISO28927 – 3-axis measurement: vibration level/measurement uncertainty.

Air Drills, Screwdrivers and Specialty Tools | Specialty Tools (incl. cutting tools)

426
Reversible cut-off tool



- 75 mm (3")
- Only 0.9 kg weight
- Composite housing
- Variable-speed lever
- Rear exhaust directs air away from the operator
- Includes 5 cutting discs

324-1
Pin Stripe Remover



- 450 W
- Only 0.8 kg weight for a work without effort
- Variable-speed lever allows precise delivery of power and speed
- Rear exhaust directs air away from the operator
- Includes 1 rubber pad

Also available

324
Pin Stripe Remover kit 12 pads

327-EU
Tire Buffer



- 10 mm (3/8") standard chuck
- 0.38 kW
- Only 0.73 kg

327LS
Tire Buffer



- 0.38 kW
- 3,000 rpm
- Only 0.50 kg
- Piped-away exhaust system

Ref.	CCN	kWatt	1 min rpm	kg	mm	in	mm	l/s	l/s	dB(A)	m/s ² /K ⁽¹⁾
426	47509194001	0.48	20,000	0.90	206	1/4 NPT	10	12.3	0.00	92.1	4.3/0.9
324-1	47515703001	0.45	3,700	0.80	200	1/4 NPT	10	13.2	0.00	89.0	3.3/0.7
324	47509197001	0.45	3,700	0.80	200	1/4 NPT	10	13.2	0.00	89.0	3.3/0.7
327-EU	01343771	0.38	22,000	0.73	224	1/4 NPT	10	7.1	12.60	87.9	4.6/1.1
327LS	01371699	0.38	-	0.50	-	1/4 NPT	10	6.6	12.60	77.4	2.5

⁽¹⁾ ISO28927 – 3-axis measurement: vibration level/measurement uncertainty.

Air Drills, Screwdrivers and Specialty Tools | Specialty Tools (incl. cutting tools)

325B

Air Nibbler



- Cutting capacity: 1.2 mm (18-gauge, 0.05")
- 4,200 blows per minute
- Variable speed lever

529

Reciprocating saw



- Stroke: 10 mm
- 9,500 strokes per minute
- Only 0.54 kg
- Variable speed lever
- 360° adjustable exhaust
- Contains: blades (6 pieces)

4429

Reciprocating saw



- Stroke: 10 mm
- 5,000 strokes per minute
- Variable speed lever
- Piped-away exhaust system

Accessories:

P4FS-6

CCN: 45525474

Blades, 12 teeth/cm (6 pieces)

P4CS-6

CCN: 45525508

Blades, 10 teeth/cm (6 pieces)



7802SA

Air shear



- Cutting capacity: 1.0 mm (20-gauge, 0.04")
- 4,200 blows per minute

LA415-EU

Air Riveter



- Aluminum rivet capacity: 2.4 – 6.35 mm (3/32 – 1/4")
- Stroke: 16 mm

Air Drills, Screwdrivers and Specialty Tools | Specialty Tools (incl. cutting tools)

LA437-EU

Air Riveter



- Aluminum rivet capacity: 2.4 – 4.75 mm (3/32 – 3/16")

LA428-EU

Caulking gun



- Power regulator
- Cartridge size: 50 x 215 mm

94058

Blow Gun



- Maximum operating pressure: 10.3 bar
- Flow 6.4 l/s
- Air inlet diameter: 1/4" BSP

LA418A-EU

Window screen Cutter



- 20,000 strokes per minute
- Variable speed lever
- Piped-away exhaust system
- Supplied without blades
- Oscillation angle 3°

Available blades for LA418A-EU

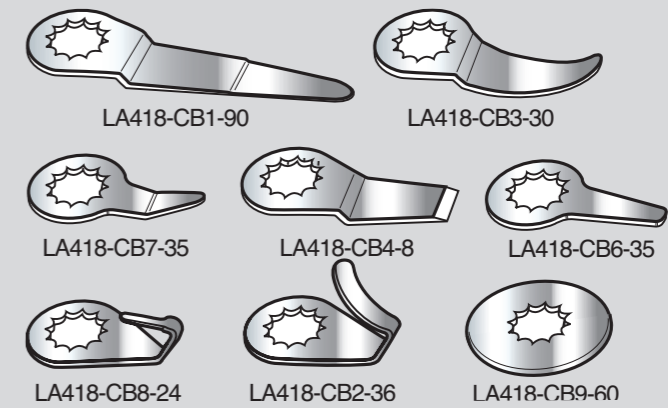

LA418-CB1-90

LA418-CB3-30

LA418-CB7-35

LA418-CB4-8

LA418-CB6-35

LA418-CB8-24

LA418-CB2-36

LA418-CB9-60

Ref.	CCN	bpm	mm	kg	mm	in	mm	l/s	l/s	dB(A)	m/s ² /K ⁽¹⁾
325B	49806568	4,200	–	1.0	185	1/4 NPT	10	1.9	8	96.0	15.9/1.9
529	47125885	9,500	10	0.7	246	1/4 NPT	6	0.5	1	84.3	3.1/1.0
4429	01371822	5,000	10	0.7	234	1/4 NPT	6	1.9	4	66.2	9.5/2.4
7802SA	80113681	4,200	–	1.3	239	1/4 NPT	10	1.9	10	83.0	3.0/1.0
LA415-EU	01330141	–	16	2.0	197	1/4 NPT	10	–	2	86.8	< 2.5

⁽¹⁾ ISO28927 – 3-axis measurement: vibration level/measurement uncertainty.

Ref.	CCN	mm	mm	kg	mm	in	mm	l/s	l/s	dB(A)	m/s ² /K ⁽¹⁾
LA437-EU	01328608	2.40 – 4.75	16	2.80	164	1/4 NPT	10	–	1.80	89.0	3.2/0.7
LA428-EU	01330067	–	215	1.30	356	1/4 NPT	10	–	–	70.0	2.5
94058	25011222	–	–	–	–	1/4 BSP	–	–	6.40	–	–
LA418A-EU	01336353	–	3	1.00	208	1/4 NPT	10	1.8	12.30	90.8	6.7/2.5

⁽¹⁾ ISO28927 – 3-axis measurement: vibration level/measurement uncertainty.

Accessories

64 | Coupling and Nipples

65 | Hoses

66 | Lubricants



Accessories | Couplings & Nipples

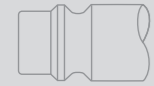

Euro 7.2 - 7.4



		Nipples BSP		Standard couplings		Safety couplings		Safety couplings		
		Ref.	CCN	Ref.	CCN	Ref.	CCN	Ref.	CCN	
Ø 7.2 – 7.4 mm				Max: 16 bar – 25 L/s ⁽¹⁾		Max: 16 bar – 25 L/s ⁽¹⁾		Max: 12 bar – 30 L/s ⁽¹⁾		
	Male thread	1/4" BSP	77NMC2	88104070	7N7CCMC2	25010505	757CCMC2	25010398	757CMC2	88104187
		3/8" BSP	77NMC3	88104088	7N7CCMC3	25010513	757CCMC3	25010406	757CMC3	88104195
		1/2" BSP	77NMC4	88104096	7N7CCMC4	25010521	757CCMC4	25010414	757CMC4	88104203
	Female thread	1/4" BSP	77NFC2	88104047	7N7CCFC2	25010471	757CCFC2	25010364	757CFC2	88104153
		3/8" BSP	77NFC3	88104054	7N7CCFC3	25010489	757CCFC3	25010372	757CFC3	88104161
		1/2" BSP	77NFC4	88104062	7N7CCFC4	25010497	757CCFC4	25010380	757CFC4	88104179
	For hose	Ø 6 mm	77NH06	88104104	7N7CCH06	25010539	757CCH06	25010422	757CH06	88104211
		Ø 8 mm	77NH08	88104112	7N7CCH08	25010547	757CCH08	25010430	757CH08	88104229
		Ø 10 mm	77NH10	88104138	7N7CCH10	25010562	757CCH10	25010455	757CH10	88104245
		Ø 13 mm	77NH13	88104146	7N7CCH13	25010570	757CCH13	25010463	757CH13	88104252



ISO 6150B MIL-C4109



		Nipples BSP		Standard couplings		Safety couplings		Safety couplings		
		Ref.	CCN	Ref.	CCN	Ref.	CCN	Ref.	CCN	
Ø 6 mm (1/4")				Max: 12 bar – 13 L/s ⁽¹⁾		Max: 16 bar – 15 L/s ⁽¹⁾		Max: 12 bar – 13 L/s ⁽¹⁾		
	Male thread	1/4" BSP	IB6NMC2	88103015	IBN6CMC2	88103197	IBS6CCMC2	25010075	IBS6CMC2	88103098
		3/8" BSP	IB6NMC3	88103023	IBN6CMC3	88103205	IBS6CCMC3	25010083	IBS6CMC3	88103106
		1/2" BSP	-	-	IBN6CMC4	88103213	IBS6CCMC4	25010091	IBS6CMC4	88103114
	Female thread	1/4" BSP	IB6NFC2	88102991	IBN6CFC2	88103163	IBS6CCFC2	25010042	IBS6CFC2	88103064
		3/8" BSP	IB6NFC3	88103007	IBN6CFC3	88103171	IBS6CCFC3	25010059	IBS6CFC3	88103072
		1/2" BSP	-	-	IBN6CFC4	88103189	IBS6CCFC4	25010067	IBS6CFC4	88103080
	For hose	Ø 6 mm	IB6NH06	88103031	IBN6CH06	88103221	-	-	IBS6CH06	88103122
		Ø 8 mm	IB6NH08	88103049	IBN6CH08	88103239	IBS6CCH08	25010117	IBS6CH08	88103130
		Ø 10 mm	IB6NH10	88103056	IBN6CH10	88103247	IBS6CCH10	25010125	IBS6CH10	88103148
Ø 8 mm (3/8")				Max: 12 bar – 33 L/s ⁽¹⁾		Max: 16 bar – 30 L/s ⁽¹⁾		Max: 12 bar – 33 L/s ⁽¹⁾		
	Male thread	1/4" BSP	IB8NMC2	88103296	IBN8CMC2	88104567	-	-	IBS8CMC2	88103395
		3/8" BSP	IB8NMC3	88103304	IBN8CMC3	88104575	IBS8CCMC3	25010158	IBS8CMC3	88103403
		1/2" BSP	IB8NMC4	88103312	IBN8CMC4	88104583	IBS8CCMC4	25010166	IBS8CMC4	88103411
	Female thread	1/4" BSP	IB8NFC2	88103262	IBN8CFC2	88104534	-	-	IBS8CFC2	88103361
		3/8" BSP	IB8NFC3	88103270	IBN8CFC3	88104542	IBS8CCFC3	25010133	IBS8CFC3	88103379
		1/2" BSP	IB8NFC4	88103288	IBN8CFC4	88104559	IBS8CCFC4	25010141	IBS8CFC4	88103387
	For hose	Ø 8 mm	IB8NH08	88103320	-	-	IBS8CCH08	25010174	IBS8CH08	88103429
		Ø 10 mm	IB8NH10	88103338	IBN8CH10	88104609	IBS8CCH10	25010182	IBS8CH10	88103437
		Ø 13 mm	IB8NH13	88103346	IBN8CH13	88104617	IBS8CCH13	25010190	IBS8CH13	88103445
Ø 11 mm (1/2")				Max: 16 bar – 70 L/s ⁽¹⁾						
	Male thread	3/8" BSP	IB11NMC3	25014028	-	-	IBS11CCMC3	25013939	-	-
		1/2" BSP	IB11NMC4	25014036	-	-	IBS11CCMC4	25013947	-	-
		3/4" BSP	-	-	-	-	IBS11CCMC6	25013954	-	-
	Female thread	3/8" BSP	IB11NFC3	25014002	-	-	IBS11CCFC3	25013905	-	-
		1/2" BSP	IB11NFC4	25014010	-	-	IBS11CCFC4	25013913	-	-
		3/4" BSP	-	-	-	-	IBS11CCFC6	25013921	-	-
	For hose	10 mm	IB11NH10	25014044	-	-	IBS11CCH10	25013962	-	-
		13 mm	IB11NH13	25014051	-	-	IBS11CCH13	25013970	-	-
		16 mm	IB11NH16	25014069	-	-	IBS11CCH16	25013988	-	-
		19 mm	IB11NH19	25014077	-	-	IBS11CCH19	25013996	-	-

(1) Measured at 6 bar (87 psig) at inlet, with 10% pressure drop as per industry standard.

Accessories | Hoses

Polyurethane Recoil Hoses

- Operating temperature: -40 to +38°C
- Operating pressure: 8 bar (115 psi) at 24°C

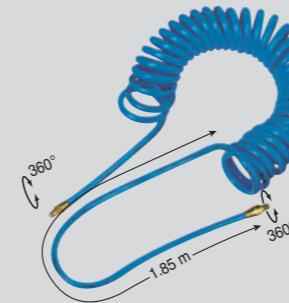
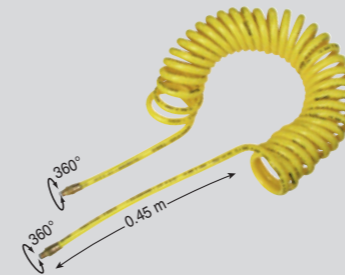

Ref.	CCN	Min. hose diameter	NPT	max m	helix max m	helix min m
Yellow Hose						
34102	92833375	6	1/4"	3	2.5	0.15
34202	92833383	6	1/4"	6	5	0.31
34302	92833391	6	1/4"	9	8	0.43
35102	92833409	8	1/4"	3	2.5	0.14
35202	92832526	8	1/4"	6	5	0.30
35302	92833417	8	1/4"	9	8	0.46
IR36103	92835172	9.5	1/4"	3	2.5	0.15
IR36203	92835180	9.5	1/4"	6	5	0.34
IR36303	92835198	9.5	1/4"	9	8	0.52
IR36102	92835149	9.5	3/8"	3	2.5	0.15
IR36202	92835156	9.5	3/8"	6	5	0.34
IR36302	92835164	9.5	3/8"	9	8	0.52
IR37102	92835206	13	1/2"	3	2.5	0.16
IR37202	92835214	13	1/2"	6	5	0.38
Blue Hose						
IR36713	88098991	9.5	3/8"	6	5	0.34
IR36715	88099015	9.5	3/8"	9	7.5	0.52

Hose Whips



Ref.	CCN	NPT	mm
33104	91486340	1/4"	300
33204	91486357	3/8"	300
33304	91488205	1/2"	300

PVC Round Hose, 30 m Coil

Safety factor 4:1



Ref.	CCN	inside mm	outside mm	Max. operating pressure at 20°C
RH-6	92545730	6	11	18 bar
RH-8	92536036	8	13	15 bar
RH-10	92536044	10	14	13 bar
RH-12	92536051	13	17	11 bar
RH-16	92536069	16	21	11 bar
RH-19	92536077	19	24	11 bar

Hose Clamps



Ref.	CCN	mm	Quantity
CO-0911	56753080	Ø 9 – 11	100
CO-1113	56753098	Ø 11 – 13	100
CO-1315	56753106	Ø 13 – 15	100
CO-1518	56753122	Ø 15 – 18	100
CO-1821	56753148	Ø 18 – 21	100
CO-2225	56753163	Ø 22 – 25	100

Index

301B.....	42	4429.....	60	7N7CCFC3.....	64
302B.....	41	49798.....	49	7N7CCFC4.....	64
307B.....	41	49799.....	49	7N7CCH06.....	64
308B.....	41	49840.....	49	7N7CCH08.....	64
3103KA.....	47	49987.....	49	7N7CCH10.....	64
3103XPA.....	47	49988.....	49	7N7CCH13.....	64
311A.....	48			7N7CCMC2.....	64
3128KA.....	47	5		7N7CCMC3.....	64
3128XPA.....	47	529.....	60	7N7CCMC4.....	64
3129KA.....	47	50P.....	66	7S7CCFC2.....	64
3129XPA.....	47	5102MAX.....	40	7S7CCFC3.....	64
312A.....	48	5108MAX.....	40	7S7CCFC4.....	64
313A.....	48			7S7CCH06.....	64
314A.....	48	6.		7S7CCH08.....	64
315A.....	48	631L.....	27	7S7CCH10.....	64
317A.....	48	67-1 LB.....	66	7S7CCH13.....	64
318A.....	48	67-4T.....	66	7S7CCMC2.....	64
319A.....	48	67-LBK1.....	66	7S7CCMC3.....	64
324-1.....	59			7S7CCMC4.....	64
325B.....	60	7		7S7CFC2.....	64
327-EU.....	59	77NFC2.....	64	7S7CFC3.....	64
327LS.....	59	77NFC3.....	64	7S7CFC4.....	64
33104.....	65	77NFC4.....	64	7S7CH06.....	64
33204.....	65	77NH06.....	64	7S7CH08.....	64
33304.....	65	77NH08.....	64	7S7CH10.....	64
34102.....	65	77NH10.....	64	7S7CH13.....	64
34202.....	65	77NH13.....	64	7S7CMC2.....	64
34302.....	65	77NMC2.....	64	7S7CMC3.....	64
3445MAX-M.....	43	77NMC3.....	64	7S7CMC4.....	64
345MAX-M.....	43	77NMC4.....	64		
35-BOOT.....	17 / 20	7802A.....	57	9	
35102.....	65	7802AKC.....	57	94058.....	61
35202.....	65	7802-BOOT.....	57	9500.....	53
35302.....	65	7802RA.....	57	9512.....	53
36QMAX.....	20	7802RAKC.....	57		
371-EU.....	58	7802SA.....	60	A	
		7803A.....	57	AA2F3M.....	32
4		7803AKC.....	57	A3F2M.....	32
426.....	59	7803-BOOT.....	57	A3F4M.....	32
4151-2-747BLK.....	49	7803RA.....	57	A4F3M.....	32
4151-747B.....	49	7803RAKC.....	57	A4F6M.....	32
4151-HL.....	46	7804KA.....	56	A6F4M.....	32
4151-HL-2.....	46	7804XPA.....	56	A6F8M.....	32
4151JV.....	49	7807R-EU.....	57	A8F6M.....	32
4152-HL.....	46	7N7CCFC2.....	64	AVC10-183.....	53

Index

B		G	
BC1110-EU.....	13	G1621.....	11
BC1121-EU.....	13	G1621EU-K2.....	11
BL1203.....	12 or 13	G1811.....	11
BL2005-BOOT.....	13	G1811EU-K2.....	11
BL2010-BOOT.....	13		
BL2012.....	13	I	
BL2022.....	13	IIB11NFC3.....	64
		IB11NFC4.....	64
C		IB11NH10.....	64
CC1101.....	12	IB11NH13.....	64
C1101EU-K2.....	12	IB11NH16.....	64
CO-0911.....	65	IB11NH19.....	64
CO-1113.....	65	IB11NMC3.....	64
CO-1315.....	65	IB11NMC4.....	64
CO-1518.....	65	IB6NFC2.....	64
CO-1821.....	65	IB6NFC3.....	64
CO-2225.....	65	IB6NH06.....	64
		IB6NH08.....	64
D		IB6NH10.....	64
D1130.....	10	IB6NMC2.....	64
D1130EU-K2.....	10	IB6NMC3.....	64
D1410.....	10	IB8NMC2.....	64
D1410EU-K2.....	10	IB8NMC3.....	64
D5140.....	10	IB8NMC4.....	64
D5140-K22-EU.....	10	IBN6CFC2.....	64
		IBN6CFC3.....	64
E		IBN6CFC4.....	64
E24H.....	32	IBN6CH06.....	64
E26H.....	32	IBN6CH08.....	64
E312H.....	32	IBN6CH10.....	64
E33H.....	32	IBN6CMC2.....	64
E36H.....	32	IBN6CMC3.....	64
E410H.....	32	IBN6CMC4.....	64
E4124H.....	32	IBN8CFC2.....	64
E43H.....	32	IBN8CFC3.....	64
E45H.....	32	IBN8CFC4.....	64
E47H.....	32	IBN8CH10.....	64
E610H.....	32	IBN8CH13.....	64
E63H.....	32	IBN8CMC2.....	64
E67H.....	32	IBN8CMC3.....	64
E810H.....	32	IBN8CMC4.....	64
E813H.....	32	IBN8NFC2.....	64
E83H.....	32	IBN8NFC3.....	64
E87H.....	32	IBN8NFC4.....	64
		IBN8NH08.....	64
		IBN8NH10.....	64
		IBN8NH13.....	64
		IBS11CCFC3.....	64
		IBS11CCFC4.....	64
		IBS11CCFC6.....	64
		IBS11CCH10.....	64
		IBS11CCH13.....	64
		IBS11CCH16.....	64
		IBS11CCH19.....	64
		IBS11CCM3.....	64
		IBS11CCM4.....	64
		IBS11CCM6.....	64
		IBS6CCFC2.....	64
		IBS6CCFC3.....	64
		IBS6CCFC4.....	64
		IBS6CCH08.....	64
		IBS6CCH10.....	64
		IBS6CCMC2.....	64
		IBS6CCMC3.....	64
		IBS6CCMC4.....	64
		IBS6CFC2.....	64
		IBS6CFC3.....	64
		IBS6CFC4.....	64
		IBS6CH06.....	64
		IBS6CH08.....	64
		IBS6CH10.....	64
		IBS6CMC2.....	64
		IBS6CMC3.....	64
		IBS6CMC4.....	64
		IBS8CCFC3.....	64
		IBS8CCFC4.....	64
		IBS8CCH08.....	64
		IBS8CCH10.....	64
		IBS8CCH13.....	64
		IBS8CCMC3.....	64
		IBS8CCMC4.....	64
		IBS8CFC2.....	64
		IBS8CFC3.....	64
		IBS8CFC4.....	64
		IBS8CH08.....	64
		IBS8CH10.....	64
		IBS8CH13.....	64
		IBS8CMC2.....	64
		IBS8CMC3.....	64

Index

IBS8CMC4.....	64	R	W5111	7	
IR36102	65	R1120.....	9	W5111-BOOT.....	7
IR36103	65	R1120EU-K2	9	W5111-K22-EU	7
IR36202	65	R1130.....	9	W5132-BOOT.....	7
IR36203	65	R1130EU-K2	9	W5133	7
IR36302	65	R3130.....	9	W5133-K22-EU	7
IR36303	65	R3130-K12-EU.....	9	W5153	7
IR36713	65	R3150.....	9	W5153-K22-EU	7
IR36715	65	R3150-K12-EU.....	9	W5330	9
IR37102	65	RH-10.....	65	W5330-BOOT.....	9
IR37202	65	RH-12.....	65	W5330-K12-EU	9
		RH-16.....	65	W5350	9
		RH-19.....	65	W5350-K12-EU	9
J		RH-6.....	65	W7150-BOOT.....	7
J2	32	RH-8.....	65	W7150EU.....	7
J3	32			W7150EU-K22	7
J4	32	S		W7152	6
J6	32	S64M17L-PS1.....	30	W7152-BOOT.....	6
J8	32	S64M18L-PS1.....	30	W7152-K22-EU	6
		S64M19L-PS1.....	30	W7152P-K22B-EU	6
L		S64M21L-PS1.....	30	W7252	6
L1110.....	12	S64M22L-PS1.....	30	W7252	6
L5110.....	12	S64M24L-PS1.....	30	W7252-K22-EU	6
LA158.....	18	S64M26L-PS1.....	30		
LA410-EU.....	57	S64M27L-PS1.....	30		
LA412-EU.....	58	SK2M12	31		
LA413-EU.....	58	SK3M8N	31		
LA415-EU.....	60	SK4M14N.....	31		
LA418A-EU.....	61	SK4M18N.....	31		
LA421-EU.....	43	SK4M3LN	31		
LA422-EU.....	43	SK4M5LN	31		
LA426-EU.....	53	SK4M7UN.....	31		
LA427-EU.....	53	SK6M6LN	31		
LA428-EU.....	61	SK8M4LN	31		
LA429-EU.....	42				
LA437-EU.....	61				
LA439-EU.....	58	V			
LUB5130.....	11	VP1-1LB.....	66		
LUB5130-K12-EU	11				
		W			
P		W1110	8		
P4CS-6	60	W1110EU-K2	8		
P4FS-6	60	W1120	8		
		W1120EU-K2	8		
		W1130	8		
		W1130EU-K2	8		



Ingersoll Rand (NYSE:IR) advances the quality of life by creating comfortable, sustainable and efficient environments. Our people and our family of brands—including Club Car®, Ingersoll Rand®, Thermo King® and Trane®—work together to enhance the quality and comfort of air in homes and buildings; transport and protect food and perishables; and increase industrial productivity and efficiency. We are a \$12 billion global business committed to a world of sustainable progress and enduring results.



www.ingersollrandproducts.com

Distributed by:

Ingersoll Rand, IR, the IR logo, IQv20 Series, IQv12 Series, Impact Wrench and Inline are trademarks of Ingersoll Rand, its subsidiaries and/or affiliates. All other trademarks are the property of their respective owners.

Nothing contained on these pages is intended to extend any warranty or representation, expressed or implied, regarding the product described herein. Any such warranties or other terms and conditions of sale of products shall be in accordance with Ingersoll Rand's standard terms and conditions of sale for such products, which are available upon request.

Product improvement is a continuing goal at Ingersoll Rand. Designs and specifications are subject to change without notice or obligation.