

# Universal grommets DU in EPDM rubber

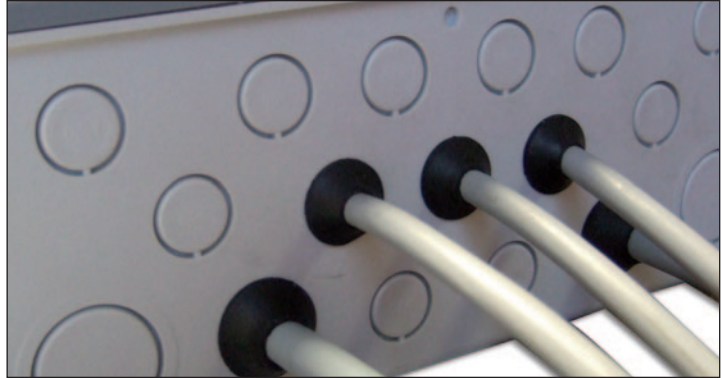

## DU

<b>Material:</b>	EPDM
<b>Colour:</b>	black
<b>Operating temperatures:</b>	-40 to +100°C
<b>Ultimate elongation:</b>	> 400 %
<b>Dielectric strength:</b>	> 13 kV/mm
<b>Resistance to ozone:</b>	very good
<b>Specification:</b>	halogene free



type	artide number	dimensions (mm)						pcs
		Ø A	Ø B	Ø C	D	F1	F2	
DU-M20	0252 0653 010	8-13	20	25,5	1...4	6,2	8	100
DU-M25	0252 0654 010	10-17	25	31	1...4	6,2	10,5	100

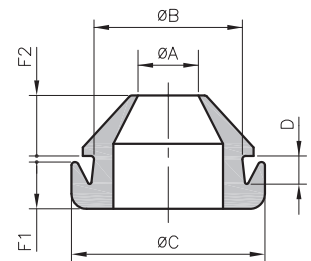

**Specification:** only one grommet adapting to a wall thickness of 1 to 4 mm.

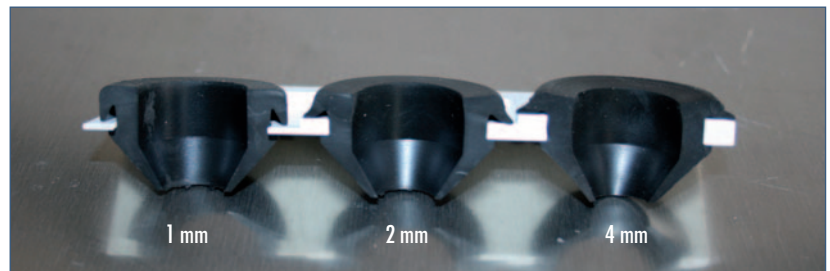

## Mounting principle

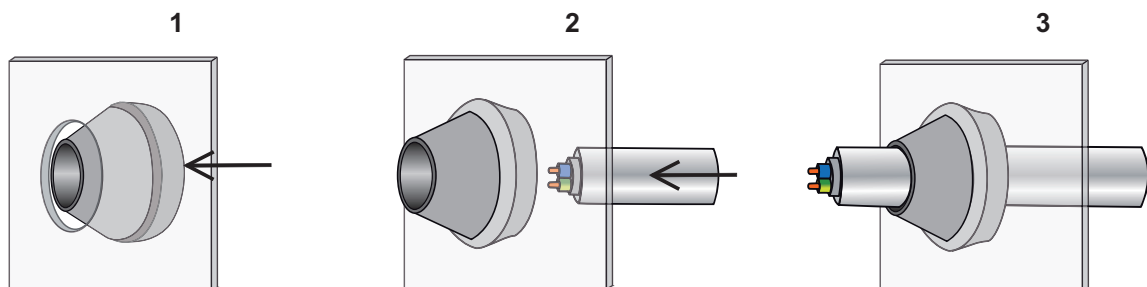

# HELAVIA® standard grommets DA in black polychloroprene rubber (Neoprene)



HELAVIA®



## DA

**Material:** polychloroprene rubber  
**Colour:** black  
**Operating temperatures:** -30 to +90°C  
**Tensile strength at break:** > 7 MPa  
**Ultimate elongation:** > 400 %  
**Dielectric strength:** > 13 kV/mm



type	article number	dimensions (mm)						pcs
		Ø A	Ø B	Ø C	D	F1	F2	
DA 20/65/10	0252 0001 010	2	6,5	11	1	2	2	100
DA 20/65/15	0252 0002 010	2	6,5	11	1,5	2	2	100
DA 20/65/20	0252 0003 010	2	6,5	11	2	2	2	100
DA 20/80/10	0252 0004 010	2	8	11	1	2	2	100
DA 20/80/15	0252 0005 010	2	8	11	1,5	2	2	100
DA 20/80/20	0252 0006 010	2	8	11	2	2	2	100
DA 30/50/10	0252 0101 010	3	5	10	1	1,5	3	100
DA 30/70/10	0252 0135 010	3	7	10	1	1,5	3	100
DA 30/70/15	0252 0136 010	3	7	10	1,5	1,5	3	100
DA 30/70/20	0252 0137 010	3	7	10	2	1,5	3	100
DA 30/70/30	0252 0138 010	3	7	10	3	1,5	3	100
DA 30/70/35	0252 0102 010	3	7	10	3,5	1,5	3	100
DA 40/65/10	0252 0010 010	4	6,5	11	1	2	2	100
DA 40/80/10	0252 0007 010	4	8	11	1	2	2	100
DA 40/80/15	0252 0008 010	4	8	11	1,5	2	2	100
DA 40/80/20	0252 0009 010	4	8	11	2	2	2	100
DA 45/95/10	0252 0085 010	4,5	9,5	13	1	4,5	4,5	100
DA 45/95/15	0252 0086 010	4,5	9,5	13	1,5	4,5	4,5	100
DA 45/95/20	0252 0087 010	4,5	9,5	13	2	4,5	4,5	100
DA 48/80/10	0252 0139 010	4,8	8	12	1	1,5	1,5	100
DA 48/80/15	0252 0140 010	4,8	8	12	1,5	1,5	1,5	100
DA 48/80/20	0252 0141 010	4,8	8	12	2	1,5	1,5	100
DA 48/80/30	0252 0142 010	4,8	8	12	3	1,5	1,5	100
DA 48/85/10	0252 0348 010	4,8	8,5	12	1	1,5	1,5	100
DA 48/85/15	0252 0349 010	4,8	8,5	12	1,5	1,5	1,5	100
DA 48/85/20	0252 0350 010	4,8	8,5	12	2	1,5	1,5	100
DA 48/85/30	0252 0011 010	4,8	8,5	12	3	1,5	1,5	100
DA 50/70/10	0252 0130 010	5	7	11	1	2,8	2,8	100
DA 50/70/15	0252 0131 010	5	7	11	1,5	2,8	2,8	100
DA 50/70/20	0252 0132 010	5	7	11	2	2,8	2,8	100
DA 50/70/30	0252 0152 010	5	7	11	3	2,8	2,8	100
DA 50/90/10	0252 0171 010	5	9	15	1	3	8	100
DA 50/90/15	0252 0172 010	5	9	15	1,5	3	8	100
DA 50/90/20	0252 0173 010	5	9	15	2	3	8	100
DA 50/90/30	0252 0174 010	5	9	15	3	3	8	100

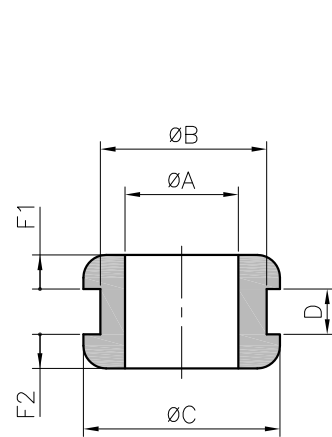

# HELAVIA® standard grommets DA in black polychloroprene rubber (Neoprene)



HELAVIA®



type	article number	dimensions (mm)						pieces
		Ø A	Ø B	Ø C	D	F1	F2	
DA 55/80/10	0252 0013 010	5,5	8	11	1	2	2	100
DA 55/80/15	0252 0014 010	5,5	8	11	1,5	2	2	100
DA 55/80/20	0252 0015 010	5,5	8	11	2	2	2	100
DA 58/100/15	0252 0016 010	5,8	10	16	1,5	3,8	3,8	100
DA 60/90/10	0252 0133 010	6	9	14	1	3	3	100
DA 60/90/15	0252 0017 010	6	9	14	1,5	3	3	100
DA 60/90/20	0252 0134 010	6	9	14	2	3	3	100
DA 60/90/30	0252 0153 010	6	9	14	3	3	3	100
DA 60/90/40	0252 0178 010	6	9	14	4	3	3	100
DA 60/100/10	0252 0018 010	6	10	14	1	3	3	100
DA 60/100/15	0252 0019 010	6	10	14	1,5	3	3	100
DA 60/100/20	0252 0020 010	6	10	14	2	3	3	100
DA 60/100/30	0252 0021 010	6	10	14	3	3	3	100
DA 60/100/40	0252 0373 010	6	10	14	4	3	3	100
DA 60/110/10	0252 0022 010	6	11	16	1	1,8	1,8	100
DA 60/110/15	0252 0023 010	6	11	16	1,5	1,8	1,8	100
DA 60/110/20	0252 0024 010	6	11	16	2	1,8	1,8	100
DA 60/110/30	0252 0143 010	6	11	16	3	1,8	1,8	100
DA 60/110/50	0252 0154 010	6	11	14	5	3	3	100
DA 60/120/10	0252 0144 010	6	12	16	1	1,8	1,8	100
DA 60/120/15	0252 0145 010	6	12	16	1,5	1,8	1,8	100
DA 60/120/20	0252 0146 010	6	12	16	2	1,8	1,8	100
DA 60/120/30	0252 0025 010	6	12	16	3	1,8	1,8	100
DA 70/120/10	0252 0147 010	7	12	16	1	3,3	3,3	100
DA 70/120/15	0252 0148 010	7	12	16	1,5	3,3	3,3	100
DA 70/120/20	0252 0088 010	7	12	16	2	3,3	3,3	100
DA 70/120/30	0252 0149 010	7	12	16	3	3,3	3,3	100
DA 75/110/10	0252 0351 010	7,5	11	20	1	3,5	3,5	100
DA 75/110/15	0252 0352 010	7,5	11	20	1,5	3,5	3,5	100
DA 75/110/20	0252 0353 010	7,5	11	20	2	3,5	3,5	100
DA 75/110/30	0252 0354 010	7,5	11	20	3	3,5	3,5	100
DA 75/110/40	0252 0355 010	7,5	11	20	4	3,5	3,5	100
DA 75/110/50	0252 0110 010	7,5	11	20	5	3,5	3,5	100
DA 75/120/10	0252 0089 010	7,5	12	20	1	3,5	3,5	100
DA 75/120/15	0252 0090 010	7,5	12	20	1,5	3,5	3,5	100
DA 75/120/20	0252 0091 010	7,5	12	20	2	3,5	3,5	100
DA 75/120/30	0252 0092 010	7,5	12	20	3	3,5	3,5	100
DA 75/120/60	0252 0026 010	7,5	12	20	6	3,5	3,5	100
DA 80/100/10	0252 0027 010	8	10	15	1	3,5	3,5	100
DA 80/100/15	0252 0028 010	8	10	15	1,5	3,5	3,5	100
DA 80/100/20	0252 0029 010	8	10	15	2	3,5	3,5	100
DA 80/100/30	0252 0030 010	8	10	15	3	3,5	3,5	100
DA 80/100/40	0252 0031 010	8	10	15	4	3,5	3,5	100
DA 80/110/10	0252 0155 010	8	11	15	1	3,5	3,5	100
DA 80/110/15	0252 0032 010	8	11	15	1,5	3,5	3,5	100
DA 80/110/20	0252 0033 010	8	11	15	2	3,5	3,5	100
DA 80/110/30	0252 0156 010	8	11	15	3	3,5	3,5	100
DA 80/110/40	0252 0157 010	8	11	15	4	3,5	3,5	100

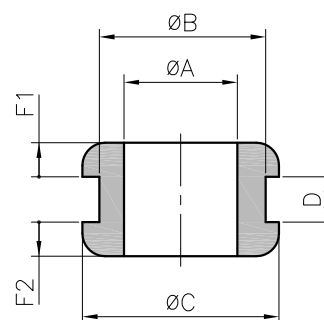

# HELAVIA® standard grommets DA in black polychloroprene rubber (Neoprene)



HELAVIA®



type	article number	dimensions (mm)						pieces
		Ø A	Ø B	Ø C	D	F1	F2	
DA 80/160/10	0252 0364 010	8	16	20	1	3	3	100
DA 80/160/15	0252 0365 010	8	16	20	1,5	3	3	100
DA 80/160/20	0252 0366 010	8	16	20	2	3	3	100
DA 80/160/30	0252 0367 010	8	16	20	3	3	3	100
DA 80/160/40	0252 0368 010	8	16	20	4	3	3	100
DA 80/160/60	0252 0175 010	8	16	20	6	3	3	100
DA 90/110/10	0252 0036 010	9	11	16	1	2,8	2,8	100
DA 90/110/15	0252 0037 010	9	11	16	1,5	2,8	2,8	100
DA 90/110/20	0252 0038 010	9	11	16	2	2,8	2,8	100
DA 90/110/30	0252 0039 010	9	11	16	3	2,8	2,8	100
DA 90/110/40	0252 0040 010	9	11	16	4	2,8	2,8	100
DA 90/160/10	0252 0158 010	9	16	22	1	4	4	100
DA 90/160/15	0252 0041 010	9	16	22	1,5	4	4	100
DA 90/160/20	0252 0159 010	9	16	22	2	4	4	100
DA 90/160/30	0252 0160 010	9	16	22	3	4	4	100
DA 90/160/40	0252 0161 010	9	16	22	4	4	4	100
DA 90/200/20	0252 0042 010	9	20	27	2	3,3	3,3	100
DA 90/200/30	0252 0043 010	9	20	27	3	3,3	3,3	100
DA 90/200/40	0252 0044 010	9	20	27	4	3,3	3,3	100
DA 95/130/10	0252 0045 010	9,5	13	17,5	1	3	3	100
DA 95/130/15	0252 0046 010	9,5	13	17,5	1,5	3	3	100
DA 95/130/20	0252 0047 010	9,5	13	17,5	2	3	3	100
DA 95/130/30	0252 0048 010	9,5	13	17,5	3	3	3	100
DA 95/130/40	0252 0049 010	9,5	13	17,5	4	3	3	100
DA 95/130/50	0252 0050 010	9,5	13	17,5	5	3	3	100
DA 95/130/80	0252 0051 010	9,5	13	17,5	8	3	3	100
DA 95/140/10	0252 0356 010	9,5	14	17,5	1	3	3	100
DA 95/140/15	0252 0357 010	9,5	14	17,5	1,5	3	3	100
DA 95/140/20	0252 0179 010	9,5	14	17,5	2	3	3	100
DA 95/140/30	0252 0359 010	9,5	14	17,5	3	3	3	100
DA 95/140/40	0252 0358 010	9,5	14	17,5	4	3	3	100
DA 100/140/10	0252 0180 010	10	14	20	1	2	2	100
DA 100/140/15	0252 0181 010	10	14	20	1,5	2	2	100
DA 100/140/20	0252 0182 010	10	14	20	2	2	2	100
DA 100/140/25	0252 0183 010	10	14	20	2,5	2	2	100
DA 100/140/30	0252 0184 010	10	14	20	3	2	2	100
DA 100/160/10	0252 0360 010	10	16	20	1	2	2	100
DA 100/160/15	0252 0083 010	10	16	20	1,5	2	2	100
DA 100/160/20	0252 0361 010	10	16	20	2	2	2	100
DA 100/160/25	0252 0362 010	10	16	20	2,5	2	2	100
DA 100/160/30	0252 0363 010	10	16	20	3	2	2	100
DA 110/140/10	0252 0093 010	11	14	19	1	3	3	100
DA 110/140/15	0252 0052 010	11	14	19	1,5	3	3	100
DA 110/140/20	0252 0094 010	11	14	19	2	3	3	100
DA 110/140/30	0252 0095 010	11	14	19	3	3	3	100
DA 110/150/10	0252 0053 010	11	15	19	1	3	3	100
DA 110/150/15	0252 0054 010	11	15	19	1,5	3	3	100
DA 110/150/20	0252 0055 010	11	15	19	2	3	3	100
DA 110/150/25	0252 0056 010	11	15	19	2,5	3	3	100
DA 110/150/30	0252 0057 010	11	15	19	3	3	3	100

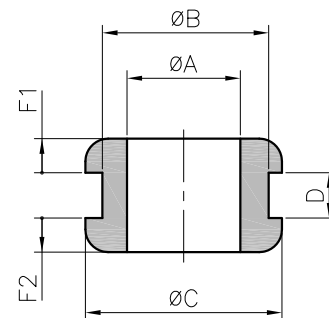

# HELAVIA® standard grommets DA in black polychloroprene rubber (Neoprene)



HELAVIA®



type	article number	Ø A	Ø B	dimensions (mm)				pcs
				Ø C	D	F1	F2	
DA 120/180/10	0252 0162 010	12	18	25	1	2,5	2,5	100
DA 120/180/15	0252 0163 010	12	18	25	1,5	2,5	2,5	100
DA 120/180/20	0252 0164 010	12	18	25	2	2,5	2,5	100
DA 120/180/30	0252 0165 010	12	18	25	3	2,5	2,5	100
DA 120/180/40	0252 0166 010	12	18	25	4	2,5	2,5	100
DA 120/200/10	0252 0167 010	12	20	25	1	2,5	2,5	100
DA 120/200/15	0252 0168 010	12	20	25	1,5	2,5	2,5	100
DA 120/200/20	0252 0169 010	12	20	25	2	2,5	2,5	100
DA 120/200/30	0252 0170 010	12	20	25	3	2,5	2,5	100
DA 120/200/40	0252 0058 010	12	20	25	4	2,5	2,5	100
DA 120/255/80	0252 0176 010	12	25,5	40	8	4	4	100
DA 120/280/80	0252 0177 010	12	28	40	8	4	4	100
DA 130/170/10	0252 0151 010	13	17	23	1	4	4	100
DA 130/170/15	0252 0059 010	13	17	23	1,5	4	4	100
DA 130/170/20	0252 0060 010	13	17	23	2	4	4	100
DA 130/170/30	0252 0061 010	13	17	23	3	4	4	100
DA 130/170/40	0252 0062 010	13	17	23	4	4	4	100
DA 130/170/50	0252 0069 010	13	17	23	5	4	4	100
DA 130/170/60	0252 0063 010	13	17	23	6	4	4	100
DA 140/200/10	0252 0064 010	14	20	28	1	4	4	100
DA 140/200/15	0252 0065 010	14	20	28	1,5	4	4	100
DA 140/200/20	0252 0066 010	14	20	28	2	4	4	100
DA 140/200/30	0252 0067 010	14	20	28	3	4	4	100
DA 140/200/40	0252 0068 010	14	20	28	4	4	4	100
DA 150/220/10	0252 0096 010	15	22	26	1	4,5	4,5	100
DA 150/220/15	0252 0097 010	15	22	26	1,5	4,5	4,5	100
DA 150/220/20	0252 0098 010	15	22	26	2	4,5	4,5	100
DA 150/220/30	0252 0099 010	15	22	26	3	4,5	4,5	100
DA 150/220/80	0252 0070 010	15	22	26	8	4,5	4,5	100
DA 160/220/10	0252 0071 010	16	22	29,5	1	4	4	100
DA 160/220/15	0252 0072 010	16	22	29,5	1,5	4	4	100
DA 160/220/20	0252 0073 010	16	22	29,5	2	4	4	100
DA 160/220/30	0252 0074 010	16	22	29,5	3	4	4	100
DA 185/250/10	0252 0343 010	18,5	25	32,5	1	4,5	4,5	100
DA 185/250/15	0252 0075 010	18,5	25	32,5	1,5	4,5	4,5	100
DA 185/250/20	0252 0344 010	18,5	25	32,5	2	4,5	4,5	100
DA 185/250/25	0252 0345 010	18,5	25	32,5	2,5	4,5	4,5	100
DA 185/250/30	0252 0346 010	18,5	25	32,5	3	4,5	4,5	100
DA 185/250/40	0252 0347 010	18,5	25	32,5	4	4,5	4,5	100
DA 200/280/10	0252 0150 010	20	28	36	1	5	5	50
DA 200/280/15	0252 0076 010	20	28	36	1,5	5	5	50
DA 200/280/20	0252 0077 010	20	28	36	2	5	5	50
DA 200/280/30	0252 0078 010	20	28	36	3	5	5	50
DA 200/280/40	0252 0079 010	20	28	36	4	5	5	50
DA 200/280/60	0252 0080 010	20	28	36	6	5	5	50
DA 230/300/20	0252 0186 010	23	30	38	2	3,5	3,5	50
DA 230/300/30	0252 0187 010	23	30	38	3	3,5	3,5	50
DA 230/300/40	0252 0188 010	23	30	38	4	3,5	3,5	50
DA 230/300/60	0252 0189 010	23	30	38	6	3,5	3,5	50

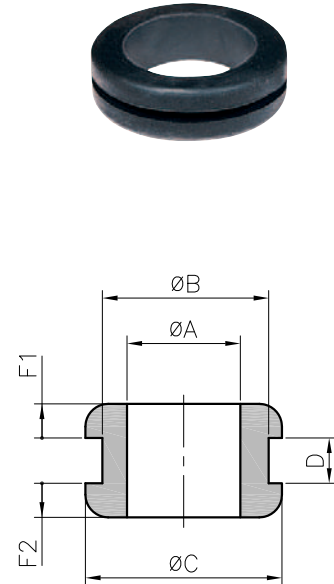

# HELAVIA® standard grommets DA in black polychloroprene rubber (Neoprene)



HELAVIA®



type	article number	dimensions (mm)						pcs
		Ø A	Ø B	Ø C	D	F1	F2	
DA 250/470/10	0252 0369 010	25	47	56,5	1	4,5	4,5	50
DA 250/470/15	0252 0081 010	25	47	56,5	1,5	4,5	4,5	50
DA 250/470/20	0252 0370 010	25	47	56,5	2	4,5	4,5	50
DA 250/470/30	0252 0371 010	25	47	56,5	3	4,5	4,5	50
DA 250/470/40	0252 0372 010	25	47	56,5	4	4,5	4,5	50
DA 300/350/10	0252 0330 010	30	35	40	1	4	4	50
DA 300/350/15	0252 0331 010	30	35	40	1,5	4	4	50
DA 300/350/20	0252 0332 010	30	35	40	2	4	4	50
DA 300/350/30	0252 0333 010	30	35	40	3	4	4	50
DA 300/350/40	0252 0334 010	30	35	40	4	4	4	50
DA 380/440/10	0252 0374 010	38	44	54	1	5	5	25
DA 380/440/15	0252 0375 010	38	44	54	1,5	5	5	25
DA 380/440/20	0252 0376 010	38	44	54	2	5	5	25
DA 380/440/30	0252 0377 010	38	44	54	3	5	5	25
DA 380/440/40	0252 0378 010	38	44	54	4	5	5	25
DA 480/600/20	0252 0335 010	48	60	68	2	3,8	3,8	25
DA 480/600/25	0252 0082 010	48	60	68	2,5	3,8	3,8	25
DA 480/600/30	0252 0336 010	48	60	68	3	3,8	3,8	25
DA 480/600/40	0252 0337 010	48	60	68	4	3,8	3,8	25
DA 480/600/60	0252 0338 010	48	60	68	6	3,8	3,8	25

